

# Commercial Audio 4x 120-watt 5-channel 4-zone 100/70V Mixer/Matrix Amplifier with Digital Media Player



P/N 18802

## User's Manual

# CONTENTS

SAFETY WARNINGS AND GUIDELINES .....	4
INTRODUCTION.....	6
FEATURES.....	6
CUSTOMER SERVICE.....	7
PACKAGE CONTENTS .....	7
PRODUCT OVERVIEW.....	8
Front Panel.....	8
Rear Panel.....	9
Remote Control.....	11
CONSTANT VOLTAGE VS LOW IMPEDANCE SPEAKER SYSTEMS .....	11
INSTALLATION.....	13
Speaker Connections .....	13
Line Out Connections.....	14
Connecting a Telephone Paging System .....	15
FM Antenna Connection.....	15
Monitor Connection.....	16
Setting Priority.....	16
Microphone and Line Connections .....	17
RS-232 Connection .....	17
Power Connection.....	17
Sample Connection Diagram .....	18
Block Diagram.....	19
INITIAL SETUP.....	20
OPERATION.....	22
Channel and Zone Controls.....	22
Media Player Controls .....	23

Bluetooth® Connection .....	24
FM Playback.....	24
MP3 Recording .....	24
RS-232 Control.....	25
SPECIFICATIONS.....	29
TECHNICAL SUPPORT .....	30
REGULATORY COMPLIANCE .....	30
Notice for FCC .....	30
Notice for Industry Canada.....	31

## SAFETY WARNINGS AND GUIDELINES

Please read this entire manual before using this device, paying extra attention to these safety warnings and guidelines. Please keep this manual in a safe place for future reference.

- Do not install this device on an unstable surface where it could fall and cause either personal injury or damage to the device and/or other equipment.
- This device is intended for indoor use only.
- Do not expose this device to water or moisture of any kind. Do not place drinks or other containers with moisture on or near the device. If moisture does get in or on the device, immediately unplug it from the power outlet and allow it to fully dry before reapplying power.
- Do not touch the device, the power cord, or any other connected cables with wet hands.
- Do not expose this device to excessively high temperatures. Do not place it in, on, or near heat sources, such as a fireplace, stove, radiator, etc. Do not leave it in direct sunlight.
- This device ventilates excessive heat through the slots and openings in the case. Do not block or cover these openings. Ensure that the device is in an open area where it can get sufficient airflow to keep from overheating.
- Do not place or install this device in an area where it can be exposed to excessive amounts of dust, humidity, oil, smoke, or combustible vapors.
- Use only in a well-ventilated area. Do not use in close, confined spaces.
- Prior to operation, check the unit and power cord for physical damage. Do not use if physical damage has occurred.
- Before plugging the unit into a power outlet, ensure that the outlet provides the same type and level of power required by the device.
- This device uses a grounded power cord and requires a ground connection for safe operation. Ensure that the power source has a proper ground connection. Do not modify the plug or use a "cheater" plug to bypass the ground connection.
- Disconnect the unit from the power source when replacing the fuse. Replace the fuse only with the same type.

- Unplug this device from the power source when not in use.
- Take care to prevent damage to the power cord. Do not allow it to become crimped, pinched, walked on, or become tangled with other cords. Ensure that the power cord does not present a tripping hazard.
- Never unplug the unit by pulling on the power cord. Always grasp the connector head or adapter body.
- Ensure that power is turned off and disconnected before making any electrical connections.
- Remove the batteries from the controller if it will go unused for a lengthy period of time.
- Clean using a soft, dry cloth only. Do not use chemical cleaners, solvents, or detergents. For stubborn deposits, moisten the cloth with warm water.
- This device has no user serviceable parts. Do not attempt to open, service, or modify this device.
- If using this amplifier to drive a 70V or 100V speaker array, ensure that the total wattage rating of the speaker array does not exceed 80% of the amplifier's rated RMS power level, i.e., 96 watts.
- Because high voltage is present on the 70V and 100V speaker output terminals, always use the terminal covers to prevent electric shock from accidental contact.
- Do not attempt to connect more than one speaker type to each Zone. You can have a 4 $\Omega$  load on one Zone and a 70V or 100V constant voltage speaker array on another Zone, but cannot mix any of the different types of speaker arrays on a single Zone.

## INTRODUCTION

Thank you for purchasing this 5-channel 4-zone Mixer/Matrix Amplifier! This amp features three combination XLR/TRS balanced/unbalanced inputs, which can be set to accept a standard microphone input, a microphone input with +48V phantom power, or a line level input. It also has two unbalanced stereo RCA line level inputs. It has four independent 120 watt amplifiers, which can drive 4-ohm loads or a 70V or 100V constant voltage speaker array. A media player is included, which features a built-in FM tuner and an mp3 player, which can playback files from a drive connected to the USB port or an SD™ card inserted in the SD/MEDIA slot. It includes thermal, short-circuit, clipping, and overload protection circuits, as well as a ground lift switch. It can also interface with external phone systems for telephone paging.

## FEATURES

- Four independent 120-watt amplifiers capable of driving 4Ω loads, as well as 70V or 100V constant voltage speaker arrays
- Three combination XLR/TRS balanced/unbalanced inputs capable of connecting microphone level, microphone level with Phantom power, or line level sources
- Two unbalanced stereo RCA inputs
- Independent gain controls on all inputs
- Any input can be directed to any or all outputs
- Balanced line outputs for each zone
- Built-in media player with FM tuner and mp3 player for playback of files on a connected USB drive or an SD™ card
- Can record the active audio sources and save as mp3 files on a connected USB drive or SD card
- RS-232 serial control
- Can interface with external phone systems for telephone paging
- Thermal, short-circuit, clipping, and overload protection circuits
- 1-watt, 8-ohm amplifier for driving a monitor speaker
- Ground lift option

## CUSTOMER SERVICE

The Monoprice Customer Service department is dedicated to ensuring that your ordering, purchasing, and delivery experience is second to none. If you have any problem with your order, please give us an opportunity to make it right. You can contact a Monoprice Customer Service representative through the Live Chat link on our website [www.monoprice.com](http://www.monoprice.com) or via email at [support@monoprice.com](mailto:support@monoprice.com). Check the website for support times and links.

## PACKAGE CONTENTS

Please take an inventory of the package contents to ensure you have all the items listed below. If anything is missing or damaged, please contact Monoprice Customer Service for a replacement.

1x 5-channel 4-zone mixer/matrix amplifier

1x AC power cord

1x User's manual

# PRODUCT OVERVIEW

## Front Panel

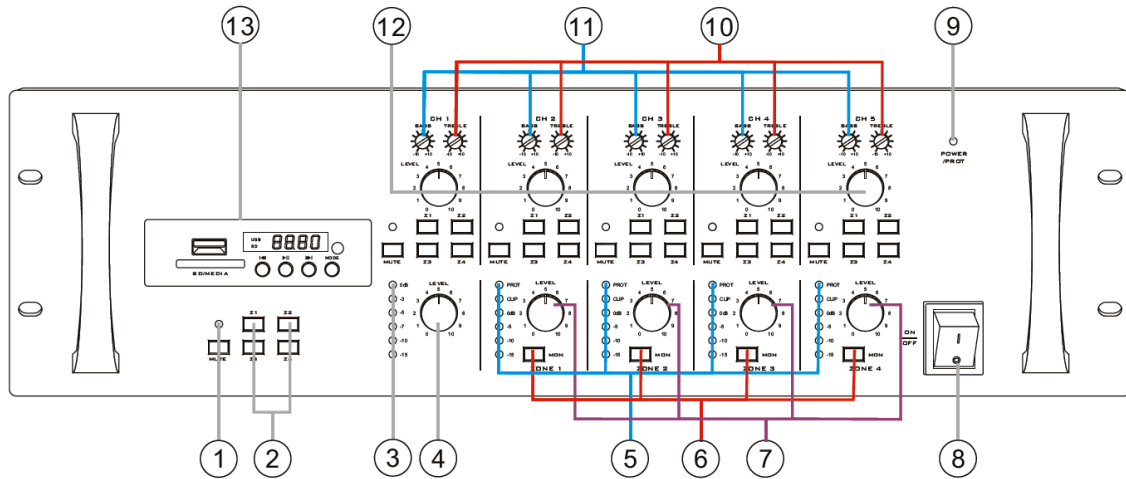

1. **MUTE Button and LED Indicator:** The LED illuminates when Mute has been activated.
2. **Z1-Z4 Buttons:** Zone selector buttons for the built-in Media Player. The buttons illuminate when selected.
3. **Monitor Level Indicators:** LED indicators show the overall output level for the Monitor.
4. **Monitor LEVEL Knob:** Adjusts the overall volume level of the Monitor.
5. **Zone 1-4 Level Indicators:** LED indicators show the output level for each of the four Zones.
6. **Zone 1-4 Monitor Buttons:** Buttons to enable or disable the Monitor for each of the four Zones. The button will illuminate when selected.
7. **Zone 1-4 LEVEL Knobs:** Adjusts the individual volume level for each of the four Zones.
8. **Power Switch:** Powers the amplifier on or off.
9. **POWER/PROTECTION LED Indicator:** The LED illuminates blue when the amplifier is powered on and illuminates red when the amplifier is in protection mode.
10. **Channels 1-5 TREBLE Controls:** Cuts or boosts the high frequency output of each individual Channel. The adjustment range is -10dB to +10dB.



11. **Channels 1-5 BASS Controls:** Cuts or boosts the low frequency output of each individual Channel. The adjustment range is -10dB to +10dB.
12. **Channels 1-5 LEVEL Knobs:** Adjusts the volume level for each individual Channel.
13. **Media Player:** The Media Player consists of a built-in FM tuner and an mp3 player with an associated SD™ card slot USB port. See the *Media Player Controls* section for operating details.

## Rear Panel

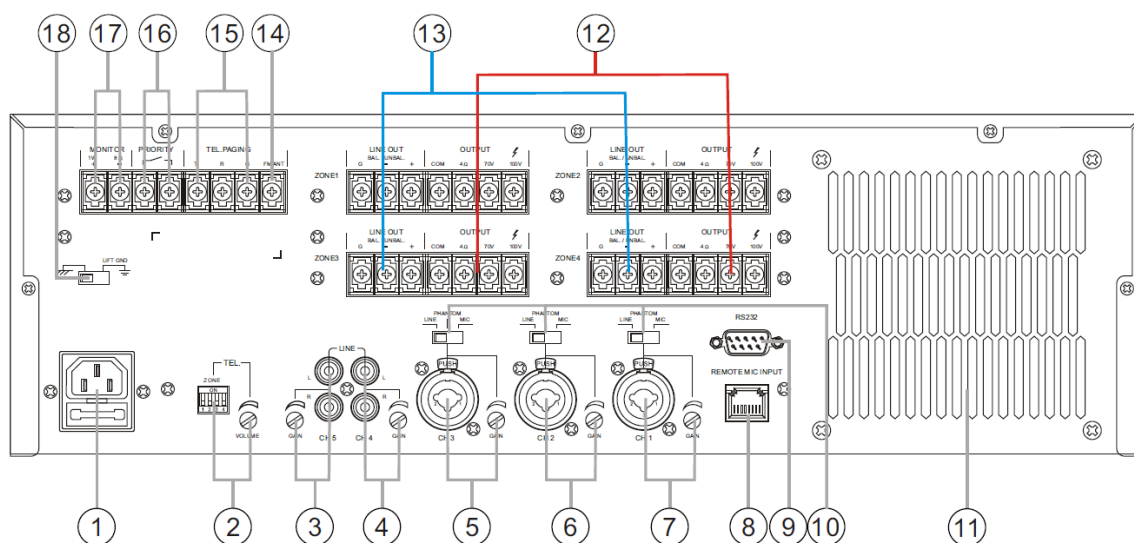

1. **AC Input Connector and Fuse Holder:** Plug the included AC power cord into the panel connector. To change the fuse, use a small screwdriver to pry the fuse holder open. A spare T12AL 250V fuse is included inside the fuse holder.
2. **TELEPHONE Zone Selector DIP Switch and VOLUME Control:** Selects which Zones that the Telephone input will broadcast and adjusts to the Telephone input volume level.
3. **Channel 5 Line Input and GAIN Control:** Stereo RCA connectors for the Channel 5 Line input and control for adjusting the amount of gain to apply to the input.
4. **Channel 4 Line Input and GAIN Control:** Stereo RCA connectors for the Channel 4 Line input and control for adjusting the amount of gain to apply to the input.
5. **Channel 3 Input and GAIN Control:** Combination XLR/TRS connector for the Channel 3 input and control for adjusting the amount of gain to apply to the input.

6. **Channel 2 Input and GAIN Control:** Combination XLR/TRS connector for the Channel 2 input and control for adjusting the amount of gain to apply to the input.
7. **Channel 1 Input and GAIN Control:** Combination XLR/TRS connector for the Channel 1 input and control for adjusting the amount of gain to apply to the input.
8. **REMOTE MICrophone Input:** Not used.
9. **RS232 Port:** DE-9 (aka DB-9) male connector to connect a computer for automated control. See the RS-232 Control section for details.
10. **Channels 1-3 Input Type Switches:** Slide switches to select the type of input signal for Channels 1-3. Set the switch to the **LINE** position for line level input, the **MIC** position for input from a dynamic microphone, or the **PHANTOM** position for input from a condenser microphone that needs +48V phantom power.
11. **Cooling Fan:** Cooling fan and ventilations holes. Do not cover the ventilation holes.
12. **Zones 1-4 OUTPUT Connectors:** Speaker connectors for the output of each individual Zone.
13. **Zones 1-4 LINE OUTputs:** Balanced and unbalanced line output connectors for each individual Zone. Whatever is being output to the speakers will be output as a line level signal for each individual Zone.
14. **Antenna Input:** Input connector for connecting a 300-ohm FM antenna.
15. **TELEphone PAGING Input:** Balanced input connectors for connecting an external telephone paging system.
16. **PRIORITY Terminals:** The normal priority order of the inputs is:

Channel 1, Telephone, Channel 2, Channel 3, Channel 4, Channel 5, Media Player

When the priority input contacts are closed/shorted, the priority order is:

Telephone, Channel 1, Channel 2, Channel 3, Channel 4, Channel 5, Media Player

17. **MONITOR Output:** Speaker connectors for connecting a Monitor speaker. The output is 1 watt at 8 ohms.
18. **Ground Switch:** Allows you to choose normal grounding or ground lift.

## Remote Control

1. Power Button
2. Mode Button
3. Previous and Next Buttons
4. Volume Increase and Decrease Buttons
5. Number Buttons
6. Play/Pause Button
7. EQ Button
8. Mute Button
9. Cycle Play Button
10. Stop Button

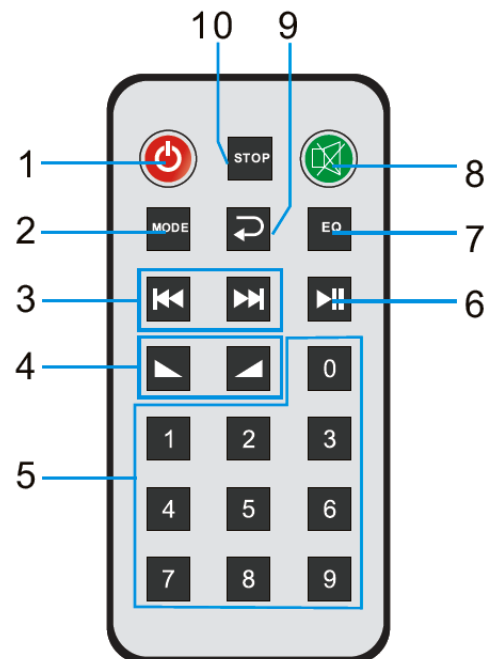

*Note: The remote control can be function at distances up to 26 feet (8 meters) and at angles up to  $\pm 35$  degrees horizontally and  $\pm 15$  degrees vertically.*

## CONSTANT VOLTAGE VS LOW IMPEDANCE SPEAKER SYSTEMS

A constant voltage speaker system differs from a traditional low impedance (e.g., 8-ohm) speaker system in that it uses a step-up transformer at the audio source to raise the voltage and lower the current on the transmission line. At the speaker end, a step-down transformer converts the signal back to a normal speaker level voltage. This reduces power loss during transmission, which allows for the use of longer speaker wire runs using smaller gauge wire.

Additionally, a constant voltage speaker system allows for the use of multiple speakers on each channel, without the need for complicated impedance calculations and configurations. In a constant voltage system, all speakers on a given channel are connected in parallel and the complicated impedance calculations are replaced by a simple wattage calculation.

For example, if you want to connect two speakers per channel in a traditional 8-ohm speaker system, you must either connect them in series, which results in an overall 16-ohm impedance, or in parallel, which results in an overall 4-ohm impedance. In the first case, the 16-ohms impedance effectively halves the output power of your amplifier, resulting in lower overall volume levels. In the latter case, the 4-ohms impedance means that your amplifier will have to work harder and must be rated as stable at 4 ohms. Adding a third speaker to the mix would complicate it further, producing either a 24-ohm or 2.67-ohm overall impedance. Note that very few amplifiers are stable under 2-ohm loads, so that is usually not an option.

On the other hand, with a constant voltage system, you consider first the RMS output wattage of the amplifier. This should be reduced by 20% to compensate for insertion loss. Each individual speaker on a given channel is set to a value such that the total does not exceed the rated power, less 20%. You do not need to worry about making the total as close as possible to the limit; just ensure that the total does not exceed the limit. For example, with this 120-watt amplifier, the total load from the speakers should not exceed 96 watts.

If all speakers are set to the same wattage value, they will all have the same volume level. If one speaker is set to a higher wattage value, it will be louder than the others, while a speaker set to a smaller value will be quieter than the others. This allows you to compensate for the environment in which the speaker is placed. For example, a speaker placed outside would need to be louder than a speaker placed in a small room.

# INSTALLATION

## Speaker Connections

This amplifier supports four separate output zones, each driven by a dedicated 120-watt amplifier. You can connect speaker arrays with an overall 4-ohm impedance or constant voltage speaker arrays at 70 or 100 volts.

1. Create up to four individual speaker arrays. If using low-impedance speakers, ensure that the overall impedance of the array is 4 ohms. If using 70 or 100 volt speakers, set the wattage value on each speaker to something that produces a total load of 96 watts or less.
2. Lift the bottom of the terminal cover over the Zone 1 **OUTPUT** connectors. Using a flat head or Phillips screwdriver, loosen the **COM** screw, then loosen the **4Ω**, **70V**, or **100V** screw, depending on the type of speaker array being connected. Note that only one type of connection can be used for each zone.

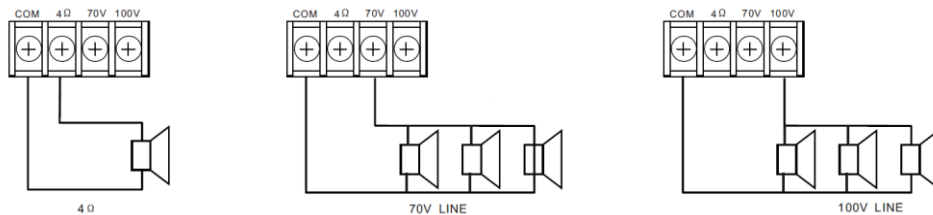

3. Insert the stripped end of the negative speaker wire lead for the first speaker array under the **COM** screw plate, then tighten the screw.
4. Insert the stripped end of the positive speaker wire lead for the first speaker array under the **4Ω**, **70V**, or **100V** screw plate, then tighten the screw.
5. Flip the terminal cover back for the **OUTPUT** terminals and press on the bottom to click it into place.
6. Repeat steps 2-5 for each other Zone.

## Line Out Connections

Each zone features a balanced/unbalanced line output that will mirror the speaker output. You can then connect this output to the input of another amplifier for more speakers in larger spaces, a subwoofer for better low-end response, mixer, an audio recorder, or other device with line level inputs. This example will use Zone 1, but applies to other Zones.

1. Prepare your balanced or unbalanced connecting cable. If connecting to a TRS or XLR input, you should make a balanced connection. If connecting to an RCA or TS input, you must make an unbalanced connection.
2. Lift the bottom of the terminal cover over the Zone 1 **LINE OUT** connectors.
3. If making an unbalanced connection, use a flat head or Phillips screwdriver to loosen the **G** and **+** screws. If making a balanced connection, loosen the - screw, as well.
4. Insert the positive lead under the **+** screw plate, then tighten the screw.
5. If making an unbalanced connection, insert the negative lead under the **G** screw plate, then tighten the screw. If making a balanced connection, insert the negative lead under the - screw plate instead, then tighten the screw.
6. If making a balanced connection, insert the ground lead under the **G** screw plate, then tighten the screw.
7. Plug the other end of the Line Out cable into the line input on your other device.
8. Flip the terminal cover for the **LINE OUT** connectors down and press the bottom to click it into place.
9. Repeat for the other Zones, as desired.

## Connecting a Telephone Paging System

This amplifier provides a 600-ohm balanced input for integrating an external telephone paging system. Perform the following steps to connect your telephone system.

1. Lift the bottom of the terminal cover over the **TEL PAGING** connectors.
2. Using a flat head or Phillips screwdriver, loosen the **T**, **R**, and **G** screws.
3. Insert the ground lead from the telephone system under the **G** screw plate, then tighten the screw.
4. Insert the ring lead from the telephone system under the **R** screw plate, then tighten the screw.
5. Insert the tip lead from the telephone system under the **T** screw plate, then tighten the screw.
6. Flip the terminal cover for the **TEL PAGING** connectors down, then press on the bottom to click it into place.
7. For those Zones you want to receive telephone paging broadcasts, slide the corresponding numbered DIP switch up to the **ON** position. Slide the other DIP switches down toward the numbers.

## FM Antenna Connection

Perform the following steps to connect a 300-ohm FM antenna.

1. Lift the bottom of the terminal cover over the **TEL PAGING** connectors.
2. Using a flat head or Phillips screwdriver, loosen the **FM** screw.
3. Insert the antenna lead under the **FM** screw plate, then tighten the screw.
4. Flip the terminal cover for the **TEL PAGING** connectors down, then press on the bottom to click it into place.

## Monitor Connection

The amplifier provides a single-channel speaker output for connecting an 8-ohm monitor speaker. Perform the following steps to connect a monitor speaker.

1. Lift the bottom of the terminal cover over the **MONITOR** connectors.
2. Using flat head or Phillips screwdriver, loosen the **1W +** and **8Ω -** screws.
3. Insert the negative speaker wire lead under the **8Ω -** screw plate, then tighten the screw.
4. Insert the positive speaker wire lead under the **1W +** screw plate, then tighten the screw.
5. Flip the terminal cover for the **MONITOR** connectors down, then press on the bottom to click it into place.

## Setting Priority

By default, the priority order of inputs is as follows:

Channel 1, Telephone, Channel 2, Channel 3, Channel 4, Channel 5, Media Player

When the priority input contacts are closed/shorted, the priority order is:

Telephone, Channel 1, Channel 2, Channel 3, Channel 4, Channel 5, Media Player

Perform the following steps if you wish to have the Telephone input take priority over Channel 1.

1. Lift the bottom of the terminal cover over the **PRIORITY** connectors.
2. Using a flat head or Phillips screwdriver, loosen the two **PRIORITY** screws.
3. Insert one end of a shorting wire under one of the screw plates, then tighten the screw.
4. Insert the other end of the shorting wire under the other screw plate, then tighten the screw.
5. Flip the terminal cover for the **PRIORITY** connectors down, then press on the bottom to click it into place.



## Microphone and Line Connections

The amplifier features three combination XLR/TRS connectors for connecting microphones or line level inputs, plus two pairs of stereo RCA connectors for line level inputs. Perform the following steps to make microphone and line connections.

1. Insert the XLR or TRS/TS connector from a microphone or line level source into the **CH 1** input.
2. If the connected device is a dynamic microphone, slide the **CH 1 Input Type Switch** to the **MIC** position. If the connected device is a condenser microphone, which requires +48V phantom power, slide the switch to the **PHANTOM** position. If the connected device is a line level source, slide the switch to the **LINE** position.
3. Repeat steps 1 and 2 for the **CH 2** and **CH 3** inputs, as desired.
4. Plug the left RCA output of your line level source into the **CH 4 L** RCA jack, then plug the right RCA output into the **CH 4 R** RCA jack.
5. Repeat step 4 for the **CH 5** input, as desired.

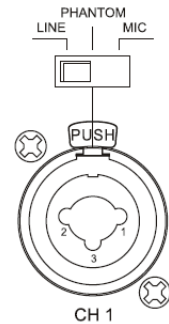

## RS-232 Connection

A 9-pin DE-9 (aka DB-9) serial connector is provided, which you can connect to a computer for automated control. Perform the following steps to connect a computer to the amplifier.

1. Plug one end of a 9-pin serial cable into the **RS232** jack on the amplifier, then tighten the screws to secure it in place.
2. Plug the other end of the serial cable into the serial connector on your computer.

## Power Connection

1. Ensure that the **Power Switch** on the front panel is in the **OFF** position.
2. Plug the included AC power cord into the **AC Input Connector and Fuse Holder**, then plug the other end into a nearby AC power outlet.

# Sample Connection Diagram

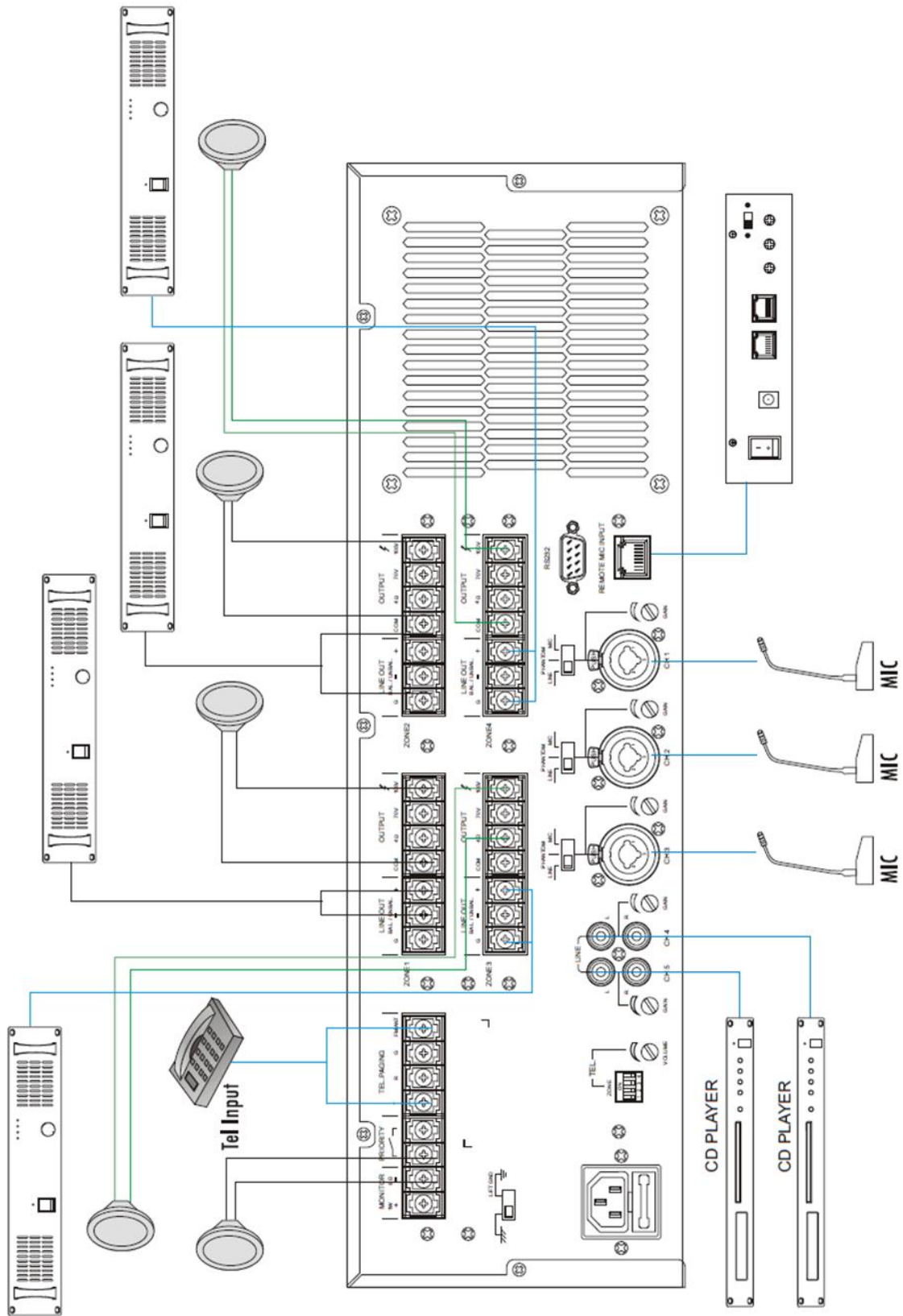

# Block Diagram

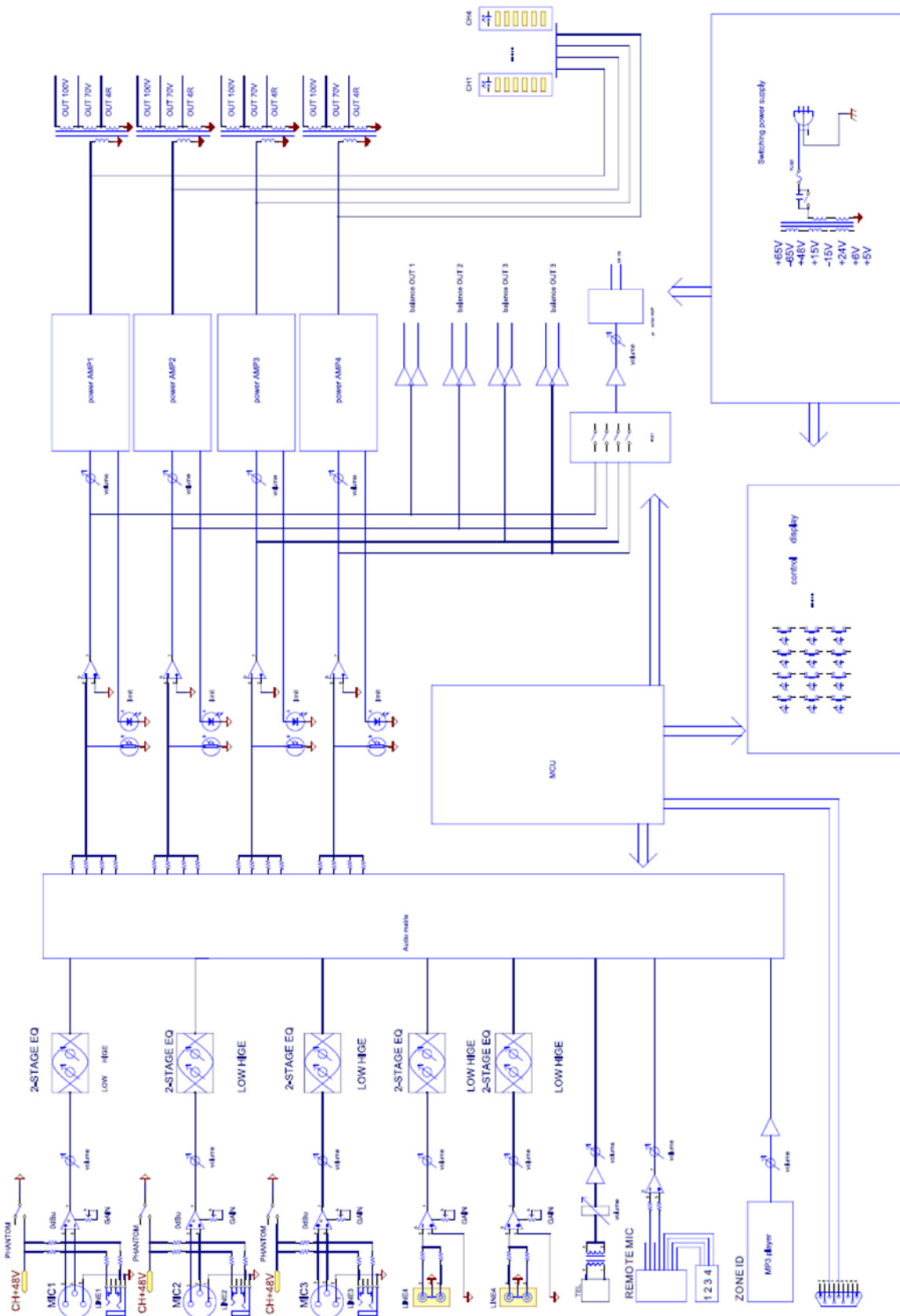

## INITIAL SETUP

Perform the following steps for the initial power on and setup.

1. Ensure that the **Power Switch** is in the **OFF** position.
2. Using a small flat head screwdriver, turn all six **GAIN** controls on the rear panel fully counterclockwise to the minimum position.
3. Using a small flat head screwdriver, set all five **BASS** and all five **TREBLE** tone controls on the front panel to the midpoint **0** position.
4. Turn all ten **LEVEL** controls on the front panel fully counterclockwise to the **0** position.
5. Flip the **Power Switch** to the **ON** position. After a few seconds, the **POWER/PROT LED** should glow blue, indicating that the amplifier is operating properly. If it glows red instead, turn the amp off and check all connections.
6. The **LCD Display** on the media player should show the time. If not, press the **MODE** button repeatedly until the time is displayed.
7. Press and hold the **MODE** button until the display starts blinking the year.
8. Using the **▶▶|** button to increase the displayed value or the **|◀◀** button to decrease the displayed value, set the displayed year to the current year.
9. Press the **MODE** button and the display will change to show the month and date, with the month flashing. Use the **|◀◀** and **▶▶|** buttons to set the displayed month to the current month.
10. Press the **MODE** button and the date will start to flash. Use the **|◀◀** and **▶▶|** buttons to set the displayed date to the current date.
11. Press the **MODE** button to display the time, with the hour value blinking. Use the **|◀◀** and **▶▶|** buttons to set the displayed hour to the current hour. Note that it uses a 24 hour clock.
12. Press the **MODE** button and the minute value will start blinking. Use the **|◀◀** and **▶▶|** buttons to set the displayed minute to the current minute.
13. Press the **MODE** button to save the newly set date and time values.
14. Press the **MODE** button until an FM frequency number is displayed.
15. Use the **|◀◀** and **▶▶|** buttons to tune to a local FM station.

16. Press and hold the **◀◀** button to decrease the volume level of the media player until the display shows **0**.
17. Press the **Z1** button underneath the media player to set the Media Player output to Zone 1.
18. Press and hold the **▶▶** to increase the output volume level of the media player step-by-step while slowly increasing the **ZONE 1 LEVEL** control until the FM station is playing at a comfortable listening level. This is the base line volume to which we will match the outputs and volume levels of the other inputs.
19. Start playback of audio on the CH 1 audio source.
20. Press the **Z1** button in the **CH 1** section to enable output of CH 1 audio to Zone 1.
21. Using a small flat head screwdriver slowly adjust the **CH 1 GAIN** control on the rear panel alternately with the **CH 1 LEVEL** control on the front panel until the volume level matches that of the FM tuner (both audio sources should be simultaneously audible on the Zone 1 speakers).
22. Press the **CH 1 Z1** button to turn off CH 1 audio from the Zone 1 speakers.
23. Repeat steps 19-22 for the CH 2-5.
24. Follow the instructions for your phone system to broadcast a page.
25. Using a small flat head screwdriver, slowly adjust the **TEL VOLUME** until the page volume is at the desired level.

*Congratulations, you have successfully installed and setup your amplifier!*

# OPERATION

## Channel and Zone Controls

This section details the Channel and Zone controls using CH 2 and ZONE 1 as an example. Other Channels and Zones are controlled the same way.

1. **BASS Control:** Adjusts the amount of bass in the CH 2 source in a range from -10dB to +10dB. Use a small flat head screwdriver to make any necessary adjustments.
2. **TREBLE Control:** Adjusts the amount of treble in the CH 2 source in a range from -10dB to +10dB. Use a small flat head screwdriver to make any necessary adjustments.
3. **CH 2 LEVEL Knob:** Adjusts the output of the CH 2 source. The CH 1-5 LEVEL controls effectively mix and balance the five inputs.
4. **MUTE Button:** Press the **MUTE** button to mute the CH 2 audio source. The LED above the button will glow when **MUTE** is enabled.
5. **ZONE Buttons:** Directs the output of CH 2 audio to any or all of the four Zones. When a Zone is enabled, the button will glow blue.
6. **ZONE 1 LEVEL Knob:** Adjusts the overall output volume level for Zone 1.
7. **MON Button:** Press the **MON** button to direct the output of Zone 1 to the Monitor. The button will glow blue when Zone 1 is being monitored.
8. **LED Indicators:** The **-15**, **-10**, **-5**, and **0dB** LEDs indicate the output level of Zone 1. When the **CLP** LED illuminates, the input source signal is too strong and should be reduced until the LED no longer illuminates. When the **PROT LED** is illuminated, the amplifier is in protection status.

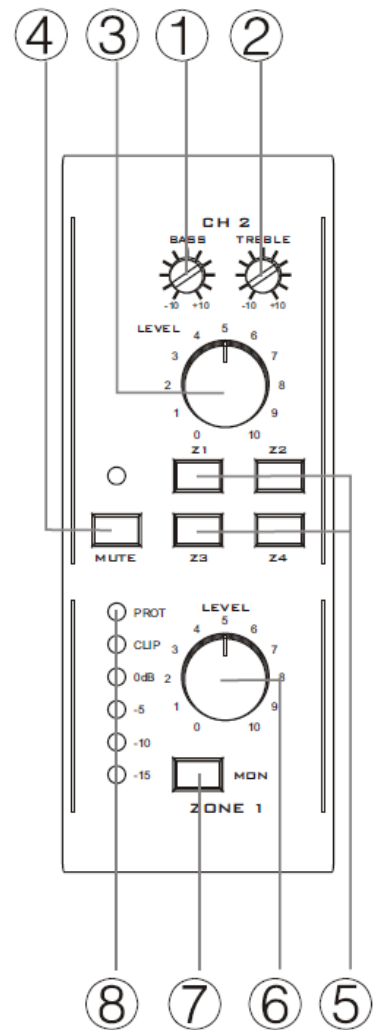

## Media Player Controls

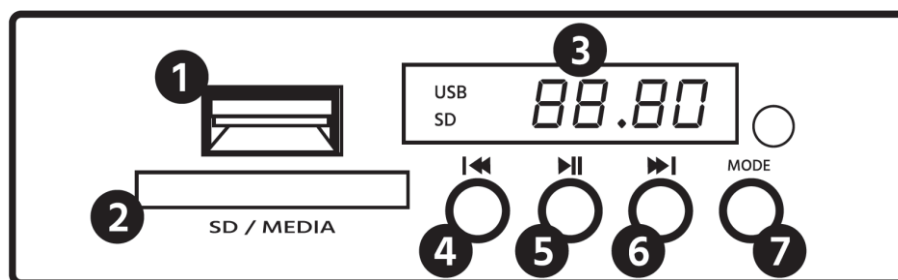

1. **USB Port:** Plug a USB device with mp3 tracks into the **USB Port** to play the audio tracks. The **USB Port** has the highest priority and the media player will automatically switch to the **USB Port** whenever a USB drive is connected. The **LCD Display** will show **USB** in the upper left corner.
2. **SD™ Card Slot:** Insert an SD™ card with mp3 tracks into the **SD Card Slot** to play the audio tracks. The **SD Card Slot** has the second highest priority and the media player will automatically switch to the **SD Card Slot** whenever an SD card is inserted. The **LCD Display** will show **SD** in the lower left corner, unless a USB drive is connected.
3. **LCD Display:** The **LCD Display** shows the track number and play time. When the media player is not being used, the **LCD Display** will show the current time.
4. **Previous Track Button:** Momentarily press the **◀** button to skip back to the previous track. Press and hold the **◀** button to decrease the volume level of the media player.
5. **Play/Pause Button:** With an audio track playing, momentarily press the **▶||** button to pause playback. With playback paused, momentarily press the **▶||** button to resume playback.
6. **Next Track Button:** Momentarily press the **▶|** button to skip ahead to the next track. Press and hold the **▶|** button to increase the volume level of the media player.
7. **MODE Button:** Momentarily press the **MODE** button to cycle through the FM Radio, Bluetooth®, and audio playback modes. Press and hold the **MODE** button to set the time and date.

## Bluetooth® Connection

Perform the following steps to establish a Bluetooth® connection between the media player and your mobile device.

1. Momentarily press the **MODE** button until the **LCD Display** shows **bt**. The media player is now ready to pair with your mobile device.
2. Open the Bluetooth settings on your mobile device and scan for nearby devices. Locate and select the **A 18802** entry.
3. Once the connection is established, you can use the controls on the media player or on your mobile device to control audio playback.

## FM Playback

Perform the following steps to use the media player's built-in FM tuner.

1. Ensure that you have an FM antenna connected to the unit and that it is close to a nearby window for improved reception.
2. Momentarily press the **MODE** button until an FM frequency is shown on the **LCD Display**.
3. Perform one of the following methods for tuning an FM station.
  - Momentarily press the **▶||** button to automatically scan for an FM station. The scan will stop on the first station with a sufficiently strong signal. Momentarily press the **▶||** button again to continue the scan until you find a station you want to listen to.
  - Use the **◀◀** and **▶▶** to manually tune to a specific FM frequency. Each press of the **◀◀** button decreases the displayed frequency by 1 MHz, while each press of the **▶▶** button increases the displayed frequency by 1 MHz.

## MP3 Recording

1. Insert an SD™ card into the **SD Card Slot** or plug a USB drive into the **USB Port**.
2. Press and hold the **▶||** button for 3 seconds. The **LCD Display** will show **REC** and the media player will begin recording an mp3 file mixed from all connected audio sources (Mic 1-4 and Aux 1-2).



3. Once the recording is finished, momentarily press the **MODE** button to end recording and save the file. The recorded file will begin playback automatically.

## RS-232 Control

This amplifier can be controlled remotely by a computer via the **RS232** port on the rear panel. After physically connecting to a computer, use a third party serial debugging assistant software to connect to the amplifier using the following settings:

9600 baud rate

No parity

8 data bits

1 stop bit

The amplifier responds to the following commands:

1. PC serial port issued instructions to get button data  
Instructions: FF 05 00 05
2. PC serial port issued instructions for the LED indicator  
Instructions: FF 05 01 06
3. PC serial port instructions for setting the priority level  
Instructions: FF 05 02 07
4. PC serial port issue instructions of get telephone, the remote switch  
Instructions: FF 05 04 09
5. PC serial port issue instructions of control MP3 connection ZONE1  
OPEN: FF 06 81 87  
CLOSE: FF 06 01 07
6. PC serial port issue instructions of control MP3 connection ZONE2  
OPEN: FF 06 82 88  
CLOSE: FF 06 02 08
7. PC serial port issue instructions of control MP3 connection ZONE3  
OPEN: FF 06 83 89  
CLOSE: FF 06 03 09

8. PC serial port issue instructions of control MP3 connection ZONE4  
OPEN: FF 06 84 8A  
CLOSE: FF 06 04 0A
9. PC serial port issue instructions of control CH1 connection ZONE1  
OPEN: FF 06 85 8B  
CLOSE: FF 06 05 0B
10. PC serial port issue instructions of control CH1 connection ZONE2  
OPEN: FF 06 86 8C  
CLOSE: FF 06 06 0C
11. PC serial port issue instructions of control CH1 connection ZONE3  
OPEN: FF 06 87 8D  
CLOSE: FF 06 07 0D
12. PC serial port issue instructions of control CH1 connection ZONE4  
OPEN: FF 06 88 8E  
CLOSE: FF 06 08 0E
13. PC serial port issue instructions of control CH3 connection ZONE1  
OPEN: FF 06 89 8F  
CLOSE: FF 06 09 0F
14. PC serial port issue instructions of control CH3 connection ZONE2  
OPEN: FF 06 8A 90  
CLOSE: FF 06 0A 10
15. PC serial port issue instructions of control CH3 connection ZONE3  
OPEN: FF 06 8B 91  
CLOSE: FF 06 0B 11
16. PC serial port issue instructions of control CH3 connection ZONE4  
OPEN: FF 06 8C 92  
CLOSE: FF 06 0C 12
17. PC serial port issue instructions of control MON connection ZONE1  
OPEN: FF 06 8D 93  
CLOSE: FF 06 0D 13

18. PC serial port issue instructions of control MON connection ZONE2  
OPEN: FF 06 8E 94  
CLOSE: FF 06 0E 14
19. PC serial port issue instructions of control MON connection ZONE3  
OPEN: FF 06 8F 95  
CLOSE: FF 06 0F 15
20. PC serial port issue instructions of control MON connection ZONE4  
OPEN: FF 06 90 96  
CLOSE: FF 06 10 16
21. PC serial port issue instructions of control CH2 connection ZONE1  
OPEN: FF 06 91 97  
CLOSE: FF 06 11 17
22. PC serial port issue instructions of control CH2 connection ZONE2  
OPEN: FF 06 92 98  
CLOSE: FF 06 12 18
23. PC serial port issue instructions of control CH2 connection ZONE3  
OPEN: FF 06 93 99  
CLOSE: FF 06 13 19
24. PC serial port issue instructions of control CH2 connection ZONE4  
OPEN: FF 06 94 9A  
CLOSE: FF 06 14 1A
25. PC serial port issue instructions of control CH4 connection ZONE1  
OPEN: FF 06 95 9B  
CLOSE: FF 06 15 1B
26. PC serial port issue instructions of control CH4 connection ZONE2  
OPEN: FF 06 96 9C  
CLOSE: FF 06 16 1C
27. PC serial port issue instructions of control CH4 connection ZONE3  
OPEN: FF 06 97 9D  
CLOSE: FF 06 17 1D

28. PC serial port issue instructions of control CH4 connection ZONE4

OPEN: FF 06 98 9E

CLOSE: FF 06 18 1E

29. PC serial port issue instructions of control CH5 connection ZONE1

OPEN: FF 06 99 9F

CLOSE: FF 06 19 1F

30. PC serial port issue instructions of control CH5 connection ZONE2

OPEN: FF 06 9A A0

CLOSE: FF 06 1A 20

31. PC serial port issue instructions of control CH5 connection ZONE3

OPEN: FF 06 9B A1

CLOSE: FF 06 1B 21

32. PC serial port issue instructions of control CH5 connection ZONE4

OPEN: FF 06 9C A2

CLOSE: FF 06 1C 22

33. MP3 Mute

OPEN: FF 06 9D A3

CLOSE: FF 06 1D 23

34. CH1 Mute

OPEN: FF 06 A2 A8

CLOSE: FF 06 22 28

35. CH2 Mute

OPEN: FF 06 9E A4

CLOSE: FF 06 1E 24

36. CH3 Mute

OPEN: FF 06 9F A5

CLOSE: FF 06 1F 25

37. CH4 Mute

OPEN: FF 06 A0 A6

CLOSE: FF 06 20 26

## 38. CH5 Mute

OPEN: FF 06 A1 A7

CLOSE: FF 06 21 27

## SPECIFICATIONS

Model	18802
Frequency Response	80Hz~16KHz
Total Harmonic Distortion	≤1%
Signal-to-Noise Ratio	≥65dB
Tone Controls	Bass: ±10dB Treble: ±10dB
Output Power	4x 120 watts
Output Interface	4Ω, 70V, 100V
Input Sensitivity and Impedance	CH1, CH2, CH3 MIC: ±2.5mV/600Ω CH1, CH2, CH3 PHANTOM: ±2.5mV CH1, CH2, CH3 LINE: ~175mV/10kΩ CH4, CH5 LINE: 350mV/10kΩ TEL: 350mV/10kΩ
Line 1-4 Output Level	1V/600Ω
SD™ Card Support	SD card up to 32GB capacity formatted for FAT16 or FAT32 with all mp3s in root directory. Does not support file folders.
Input Power	120 VAC, 50/60 Hz
Maximum Power Consumption	750 watts
Dimensions	19.1" x 17.3" x 5.2" (484 x 440 x 132 mm)
Weight	25.8 lbs. (11.7 kg)

## TECHNICAL SUPPORT

Monoprice is pleased to provide free, live, online technical support to assist you with any questions you may have about installation, setup, troubleshooting, or product recommendations. If you ever need assistance with your new product, please come online to talk to one of our friendly and knowledgeable Tech Support Associates. Technical support is available through the online chat button on our website [www.monoprice.com](http://www.monoprice.com) or through email by sending a message to [tech@monoprice.com](mailto:tech@monoprice.com). Check the website for support times and links.

## REGULATORY COMPLIANCE

### Notice for FCC



This device complies with Part 15 of the FCC rules. Operation is subject to the following two conditions: (1) this device may not cause harmful interference, and (2) this device must accept any interference received, including interference that may cause undesired operation.

Modifying the equipment without Monoprice's authorization may result in the equipment no longer complying with FCC requirements for Class B digital devices. In that event, your right to use the equipment may be limited by FCC regulations, and you may be required to correct any interference to radio or television communications at your own expense.

This equipment has been tested and found to comply with the limits for a Class B digital device, pursuant to Part 15 of the FCC Rules. These limits are designed to provide reasonable protection against harmful interference in a residential installation. This equipment generates, uses and can radiate radio frequency energy and, if not installed and used in accordance with the instructions, may cause harmful interference to radio communications. However, there is no guarantee that interference will not occur in a particular installation. If this equipment does cause harmful interference to radio or television reception, which can be determined by turning the equipment off and on, the user is encouraged to try to correct the interference by one or more of the following measures:

- Reorient or relocate the receiving antenna.
- Increase the separation between the equipment and receiver.
- Connect the equipment into an outlet on a circuit different from that to which the receiver is connected.
- Consult the dealer or an experienced radio/TV technician for help.

### **Notice for Industry Canada**

This Class B digital apparatus complies with Canadian ICES-003.

Cet appareil numérique de la classe B est conforme à la norme NMB-003 du Canada.

*SD™ is a trademark or registered trademarks of SD-3C, LLC in the United States, other countries, or both.*