

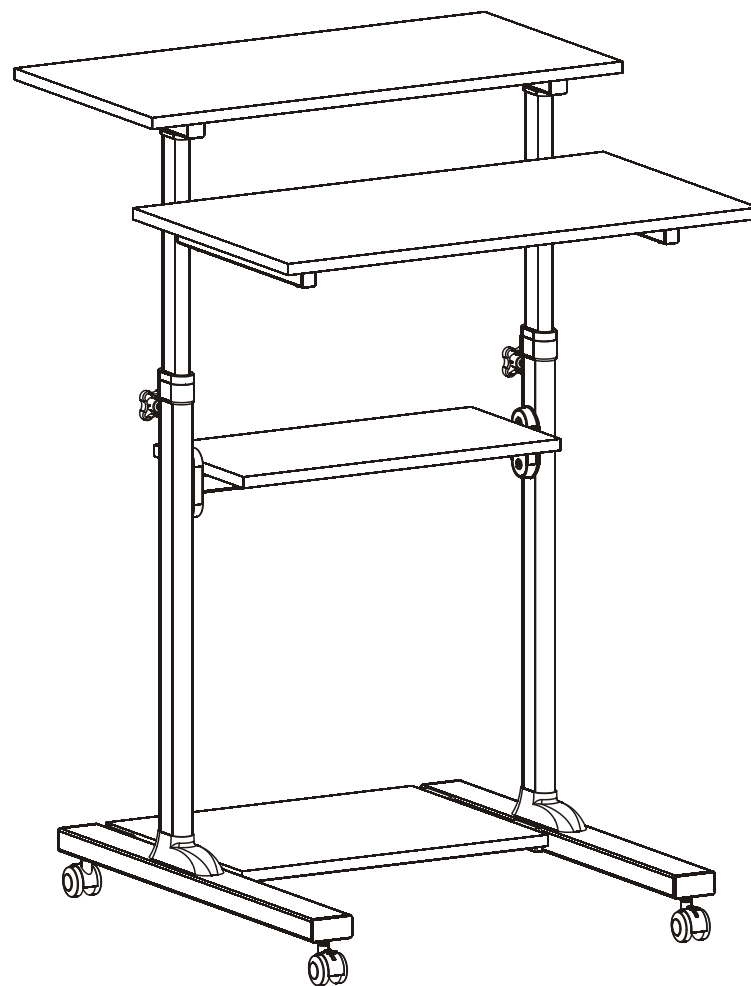







REVISION INFORMATION			
Rev.	Rev. Date	Modified By	Brief Description

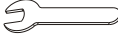

	M6x12(x12)
	M6x25(x4)
	M6x40(x4)
	M6x35(x6)
	M6x50(x4)
	A6x1
	A7x1

• All of materials satisfy the CA65, ROHS...



MONOPRICE

GENERAL TOLERANCE	APPROVED BY & DATE :	DESCRIPTION : Height Adjustable PC Workstation Cart for Sit-Stand
0-6 ±0.05	CHECKED BY & DATE :	
6-18 ±0.07	DESIGNED BY & DATE :	
18-50 ±0.10	ITEM NO. : 15723	
50-120 ±0.15	DATE : 2017/01/10	REV : A01
	UNIT : MM	SHEET: 1 OF 2
	SCALE: 1 : 1	

NO.	PART NAME	SPECIFICATION DESCRIPTION	QTY	UNIT
③				
②				
①	15723	Height Adjustable PC Workstation Cart for Sit-Stand		