

**Instruction / Installation Sheet**  
**DataComm Electronics Easy Mount Series**  
**45-0014 Cable Plate with Flexible Opening, 1-Gang**



**Parts Included**

- 1. Cable Plate with Flexible Opening, 1-Gang

**Tools Needed**

- 1. Drywall saw
- 2. 6 Ft. tape measure
- 3. Pencil
- 4. Screwdriver

Use the Cable Plate with Flexible Opening to install low voltage cables behind your flat panel TV, (see Figures 2 & 3), your amplifier or other audio and video devices. This wall plate is designed for use with **Low Voltage / Data Cables "ONLY"**.



45-0014 – Front View



45-0014 – Back View

The Cable Plate with Flexible Opening is designed with the low voltage mounting brackets molded to the back of the plate (see Figure 1).

Determine the location of your flat panel TV, amplifier or audio/video device. Use the enclosed template to cut a hole in the drywall. When cutting the hole in the drywall, allow for the location of the stud. Now simply pull your audio/video cables through the wall and through the opening in the Cable Plate with Flexible Opening. Now insert the Cable Plate with Flexible Opening flush into the wall. Next, screw down the wall plate screws with wings. The wings will fasten tightly against the back of the drywall (see Figure 3) and your installation is complete.

**This Cable Plate with Flexible Opening is Designed for Use with Low Voltage / Data Cables "ONLY".**

**Do Not Run or Pull the TV Cord or Other Electrical Cords Inside the Drywall.**

**National Electrical Code (NEC) Does Not Allow the Installation of the TV Power Cord or an Extension Cord Behind the Wall.**

**CAUTION**

- Never install low voltage wiring during lightning storms.
- Never install low voltage wiring in wet locations unless the wire is specifically designed for wet locations.
- Never touch un-insulated low voltage wires or terminals unless the wire has been disconnected at its source.
- Use caution when installing low voltage cables.

**IMPORTANT INSTRUCTIONS**

- Read and understand all instructions.
- Follow all warning and instructions marked on the product.
- Do not use this product near water, for example near a bath tub, wash bowl, kitchen sink, or laundry tub, in a wet basement, or near a swimming pool.
- **SAVE THESE INSTRUCTIONS.**

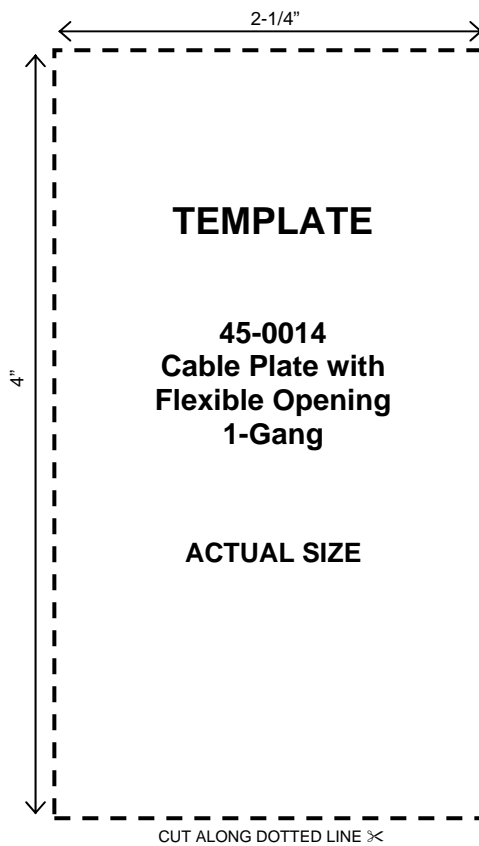
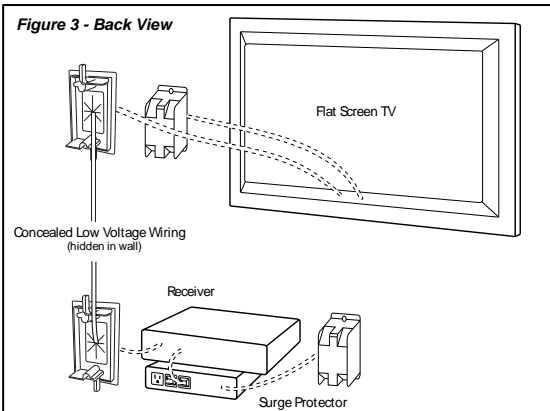
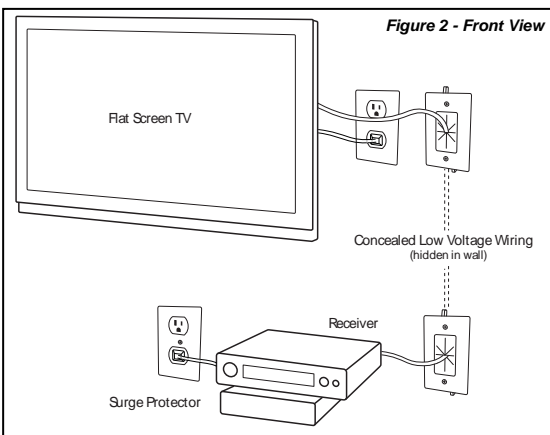
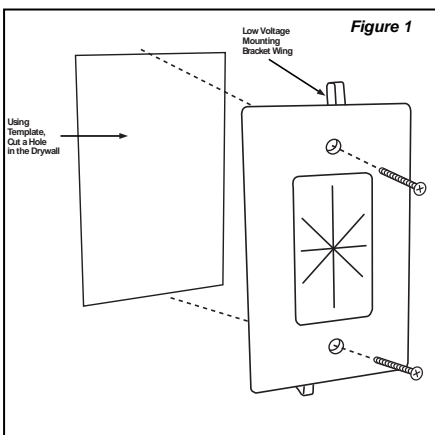

This product is patent protected by U.S. Patent number 7495171

RoHS Compliant



**Instruction / Installation Sheet**  
**DataComm Electronics Easy Mount Series**  
**45-0015 Cable Plate with Flexible Opening, 2-Gang**



45-0015 – Front View

45-0015 – Back View

**Parts Included**

1. Cable Plate with Flexible Opening, 2-Gang

**Tools Needed**

1. Drywall saw
2. 6 Ft. tape measure
3. Pencil
4. Screwdriver

Use the Cable Plate with Flexible Opening to install low voltage cables behind your flat panel TV, (see Figures 2 & 3), your amplifier or other audio and video devices. This wall plate is designed for use with **Low Voltage / Data Cables “ONLY”**.

The Cable Plate with Flexible Opening is designed with the low voltage mounting brackets molded to the back of the plate (see Figure 1).

Determine the location of your flat panel TV, amplifier or audio/video device. Use the enclosed template to cut a hole in the drywall. When cutting the hole in the drywall, allow for the location of the stud. Now simply pull your audio/video cables through the wall and through the opening in the Cable Plate with Flexible Opening. Now insert the Cable Plate with Flexible Opening flush into the wall. Next, screw down the wall plate screws with wings. The wings will fasten tightly against the back of the drywall (see Figure 3) and your installation is complete.

**This Cable Plate with Flexible Opening is Designed for Use with Low Voltage / Data Cables “ONLY”.**

**Do Not Run or Pull the TV Cord or Other Electrical Cords Inside the Drywall.**

**National Electrical Code (NEC) Does Not Allow the Installation of the TV Power Cord or an Extension Cord Behind the Wall.**

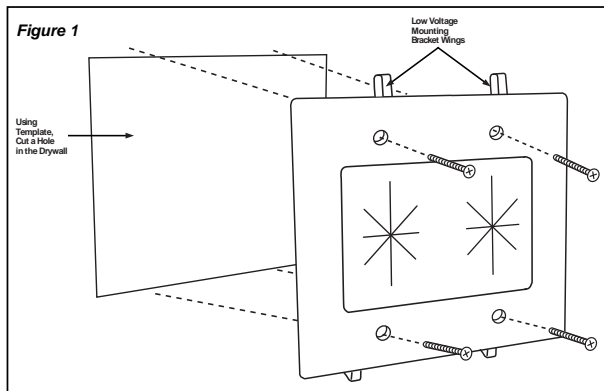

**CAUTION**

- Never install low voltage wiring during lightning storms.
- Never install low voltage wiring in wet locations unless the wire is specifically designed for wet locations.
- Never touch un-insulated low voltage wires or terminals unless the wire has been disconnected at its source.
- Use caution when installing low voltage cables.



**IMPORTANT INSTRUCTIONS**

- Read and understand all instructions.
- Follow all warning and instructions marked on the product.
- Do not use this product near water, for example near a bath tub, wash bowl, kitchen sink, or laundry tub, in a wet basement or near a swimming pool.
- **SAVE THESE INSTRUCTIONS.**

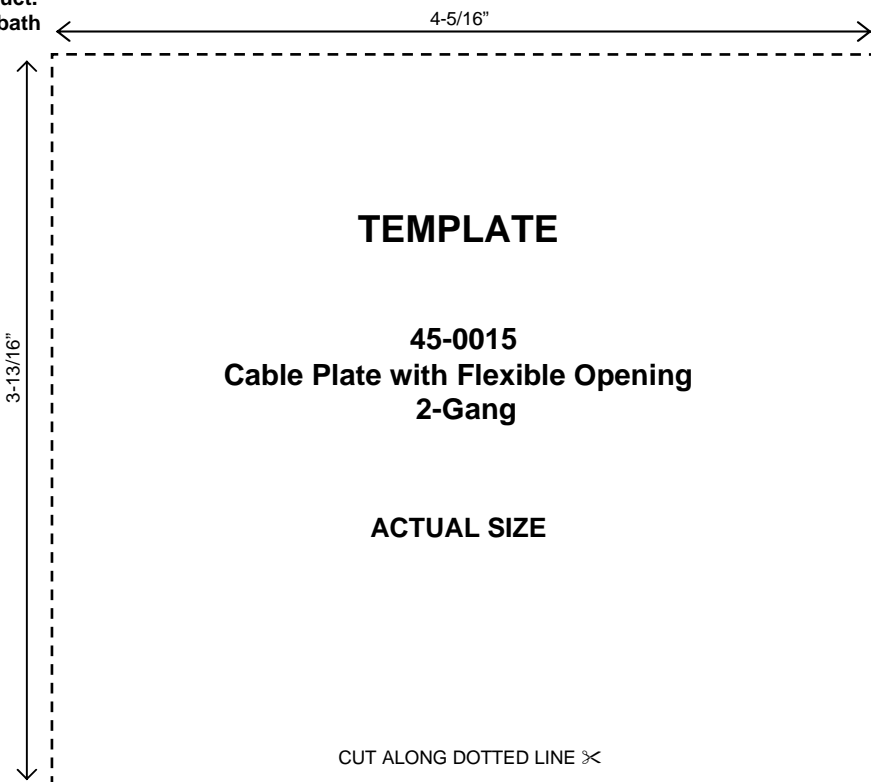
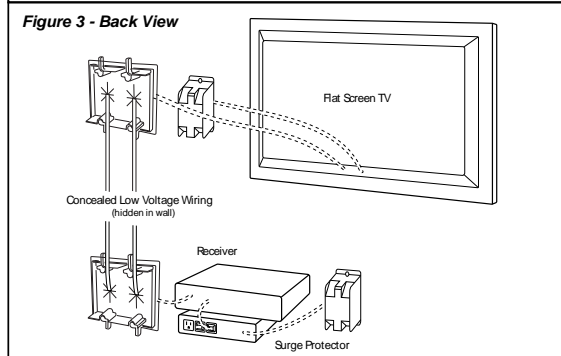
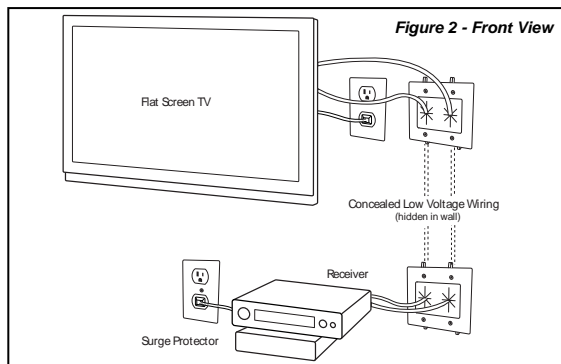

This product is patent protected by U.S. Patent number 7495171. RoHS Compliant.