



# THE HUBSAN X4

2.4GHZ RC SERIES 4 CHANNEL



ITEM NO.:H107  
FLIP TIPS SEE PAGE 14-16

# CATALOG

INTRODUCTION .....	02
SAFETY NOTES .....	02
SAFETY CHECK BEFORE FLYING .....	04
CHARGING THE LI-PO BATTERY .....	05
TRANSMITTER .....	06
FLY THE X4 .....	09
ADVANCED PERFORMANCE SETUP .....	12
REPLACING PROPELLERS .....	16
REMOVING AND INSTALLING LEDS .....	18
EXPLODED VIEW .....	19
H107 TROUBLESHOOTING .....	20
SPARE PART CHART .....	23

# 1 INTRODUCTION

---

Thank you for buying HUBSAN products. The X4 quadcopter is designed as an easy-to-use, full-featured RC model capable of hovering, fast forward, and aerobatic flight maneuvers. Please read the manual carefully and follow all instructions in it. Be sure to retain the manual for future reference, routine maintenance, and tuning.

## 2 SAFETY NOTES

---

### ***2.1 Important Notes***

This RC quadcopter is not a toy.

Any improper use of this product will result in serious injury. Be aware of your personal safety, safety of others and your surrounding environment.

We recommend beginners learn to fly with more experienced pilots playing nearby before attempting to fly the X4 for the first time.

### ***2.2 Caution***

The X4 quadcopter has parts that move at high speed, which poses a certain degree of danger.

Choose a wide open space without obstacles. Do not operate the X4 near buildings, crowds of people, high voltage cables, or trees to ensure the safety of yourself, others and your model.

Improper operation may cause damage to people and property.

### ***2.3 LiPo Battery Safety Notes***

The X4 is powered by a Lithium-Polymer (LiPo) battery.

To avoid risk of fire or damage, never recharge your battery while it is inserted in the X4.

If you do not plan to fly the X4 for a week or more, store the battery approximately 50% charged to maintain battery performance and life.



## **SAFETY ADVISORY NOTICE**

### **Lithium-Polymer (LiPo) Batteries**

LiPo batteries are different from conventional batteries in that their chemical contents are encased in a relatively lightweight foil packaging. This has the advantage of significantly reducing their weight, but does make them more susceptible to damage if roughly or inappropriately handled. As with all batteries, there is a risk of fire or explosion if safety practices are ignored:

- ☑ Charge and store LiPo batteries in a location where a battery fire or explosion (including smoke hazard) will not endanger life or property.
- ☑ Keep LiPo batteries away from children and animals.
- ☑ Never charge the LiPo battery that has ballooned or swelled.
- ☑ Never charge the LiPo battery that has been punctured or damaged.
- ☑ After a crash, inspect the battery pack for the sign of damage. Discard in accordance with your country's recycling laws.
- ☑ Never charge the LiPo battery in a moving vehicle.
- ☑ Never overcharge the LiPo battery.
- ☑ Never leave the LiPo battery unattended during recharging.
- ☑ Do not charge LiPo batteries near flammable materials or liquids.
- ☑ Ensure that charging leads are connected correctly. Reverse polarity charging can lead to battery damage or a fire or explosion.
- ☑ Have a suitable fire extinguisher (electrical type) OR a large bucket of dry sand near the charging area. Do not try to extinguish electrical (LiPo) battery fires with water.
- ☑ Reduce risks from fire/explosion by storing and charging LiPo batteries inside a suitable container.
- ☑ Protect your LiPo battery from accidental damage during storage and transportation. (Do not put battery packs in pockets or bags where they can short circuit or can come into contact with sharp or metallic objects.).
- ☑ If your LiPo battery is subjected to a shock (such as a crash), place it in a metal container and observe for signs of swelling or heating for at least 30 minutes.
- ☑ Do not attempt to disassemble or modify or repair the LiPo battery.

## **2.4 Prevent Moisture**

The X4 contains many precision electrical components.

Store the battery and the X4 in a dry area at room temperature. Exposure to water or moisture may cause malfunction resulting in loss of responsiveness, or a crash.

## **2.5 Proper Operation**

For safety only use the included HUBSAN spare parts for replacement.

## **2.6 Always Be Aware of the Rotating Blades**

When in operation, the main and tail rotor blades will be spinning at high speed. The blades are capable of inflicting serious body injury or property damage.

Be careful to keep your body and loose clothing away from the blades. Never take your eyes off the X4 or leave it unattended while it is turned on. Stop operating immediately if the X4 flies out of your view. Once landed, immediately turn off the X4 and transmitter.

## **2.7 Avoid Flying Alone**

Beginners should avoid flying alone when learning flight skills. We recommend flying with an experienced pilot nearby in case you need help.

# **3 SAFETY CHECK BEFORE FLYING**

---

## **CAREFULLY INSPECT THE X4 BEFORE EVERY FLIGHT**

- Before operation, check the batteries of the transmitter and X4 are charged for the flight.
- Before turning on the transmitter, check that the throttle stick is pulled completely backward (down position).
- Carefully check rotor blades and rotor holders. Broken parts will pose risk of injury and hazard.
- Check the battery and power plug are securely fastened. Severe vibration during flight may detach the plug and result in loss of control.
- When turning on the unit, always turn on the transmitter first, and then turn on the X4. To power off, always turn off the X4 first and then the transmitter. Improper procedure may cause loss of control of the quadcopter .

## 4 CHARGING THE LI-PO BATTERY

### 4.1 3.7V 280mAh LiPo Battery

4.1.1 Take out the battery from the bottom of the X4.

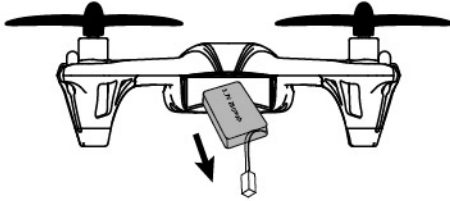

4.1.2 Connect the battery with USB charger, then connect the USB charger to a computer or other USB connector, such as a smartphone charger. The LED lights up while charging and turns off when charging is complete. The voltage of the USB is  $+5\pm 0.5V$ .

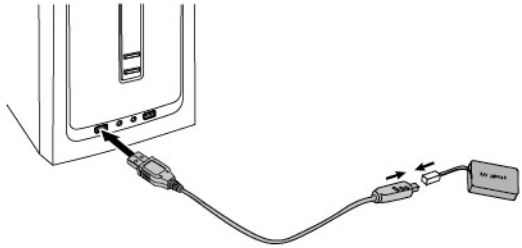

### 4.2 Safety Advisory Notice

Always partially charge your LiPo battery before storage. LiPo batteries retain the power over a reasonable period; It is not normally necessary to recharge stored LiPo batteries unless stored for periods longer than 3-6 months.

If your LiPo battery has been over-discharged, it will not be possible to recharge it again.



#### LiPo Battery Disposal & Recycling



Lithium-Polymer(LiPo) batteries must not be placed in with household trash. Please contact your environmental or waste agency or the supplier of your model for local regulations and the location of your nearest LiPo battery recycling center.

## 5 TRANSMITTER

### 5.1 Identification and Functions of the Main Menu

#### Main Menu

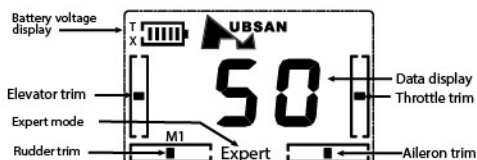

**MODE 1**



**MODE 2**

#### TRANSMITTER

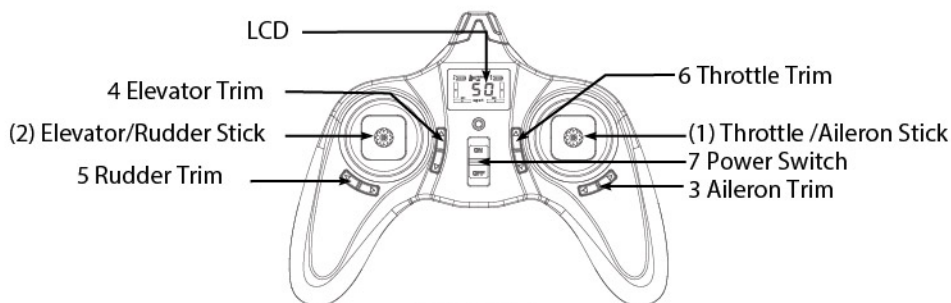

**MODE 1**

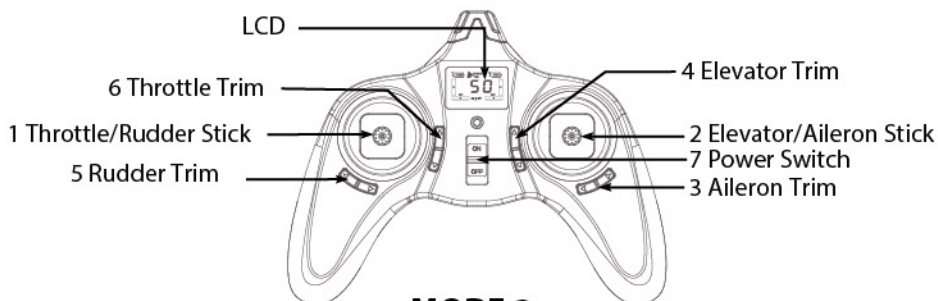

**MODE 2**



## Input Key Function

S/N	Mode/ Control	Function
(1)	<b>MODE 1</b> Throttle /Aileron Stick	Move the stick forward or backward to increase or decrease speed . Move the stick left or right to make the quadcopter roll left or right to initiate a banked turn.
(2)	<b>MODE 1</b> Elevator/Rudder Stick	Move the stick forward or backward to make the quadcopter nose point up or down. Move the stick left or right to make the quadcopter yaw left or right.
1	<b>MODE 2</b> Throttle/Rudder Stick	Move the stick forward or backward to make the quadcopter ascend or descend. Move the stick left or right to rotate the quadcopter's fuselage left or right.
2	<b>MODE 2</b> Elevator/Aileron Stick	Move the stick forward or backward to make the quadcopter move forward or backward. Move the stick left or right to make the quadcopter drift sideways left or right.
3	Aileron Trim	Aileron trim adjusts for left and right drift.
4	Elevator Trim	Elevator trim adjusts for forward and backward drift.
5	Rudder Trim	Rudder trim adjusts for drift of left and right rotation or yaw.
6	Throttle Trim	Throttle trim normally left at neutral. The lower trim turns LEDs on and off.
7	Power Switch	Push to ON to turn on the transmitter. Push to OFF to turn off.

### Electrical and electronic equipment that are supplied with batteries (including internal batteries)

#### WEEE Directive & Product Disposal

At the end of its serviceable life, this product should not be treated as household or general waste. It should be handed over to the applicable collection point for the recycling of electrical and electronic equipment, or returned to the supplier for disposal.

Internal / Supplied Batteries.

This symbol on the battery indicates that the battery is to be collected separately.

This battery is designed for separate collection at an appropriate collection point.





## 5.2 Transmitter Stick Calibration

**Mode 2:** Push both sticks to the upper left position and hold, then power on the transmitter. Rotate both sticks twice. Hold down any trim until the LED on the transmitter blinks red, indicating successful calibration.

**Mode 1:** Push the left stick to the upper left position and right stick to the upper right position and hold, then power on the transmitter. Rotate both sticks twice. Hold down any trim until the LED on the transmitter blinks red, indicating successful calibration.

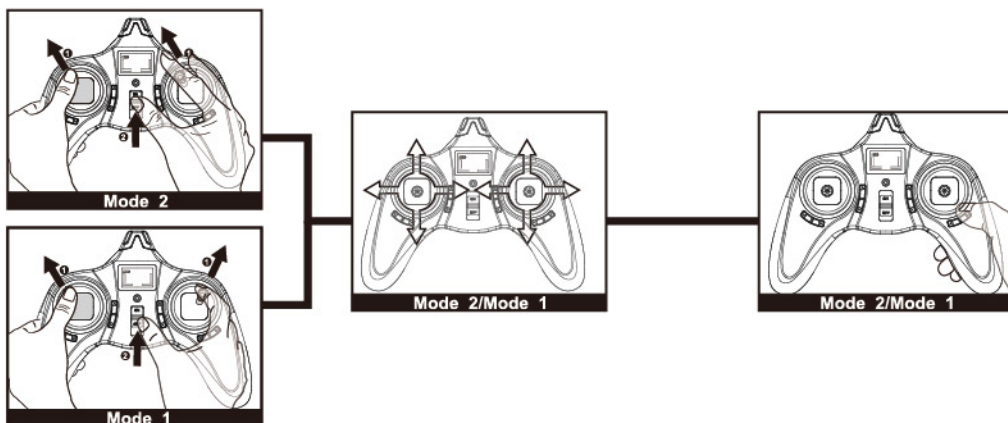

## 5.3 Transmitter Battery Installation

**Notice:** Do not mix old and new batteries.

Do not mix different types of batteries.

Do not charge non-rechargeable batteries.

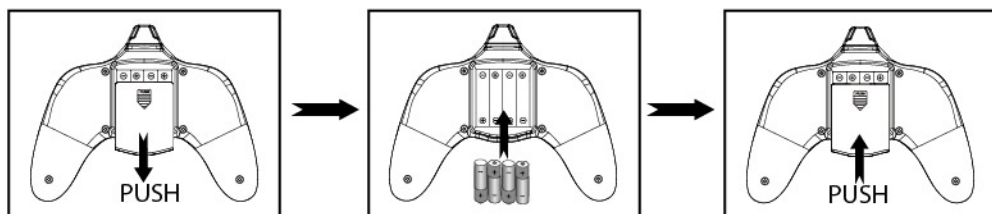

Remove the cover

Install 4 x AAA batteries  
according to the correct polarities

Replace cover

## 6 FLY THE X4

### 6.1 Power-On Safety Mode

Your X4's flight controller is designed with a Power-On safety feature that ensures that the X4's motor will not start unless it detects a suitable control signal when the LiPo battery is connected.

6.1.1 Make sure the throttle stick is in the full down position.

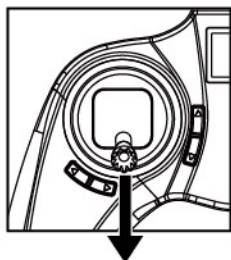

MODE 2

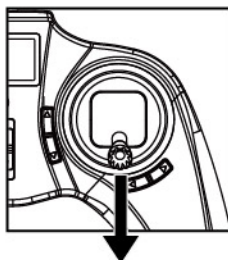

MODE 1

6.1.2 Power on the transmitter and the red LED will blink. Do not move any other stick or trim before the transmitter and X4 finish pairing, or the X4 will drift. The transmitter LED will turn green after pairing is successfully completed.

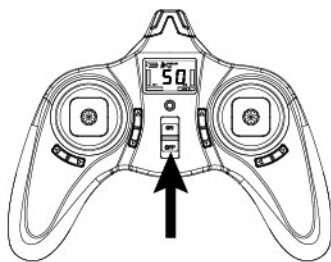

6.1.3 Connect the battery plug with correct polarity.

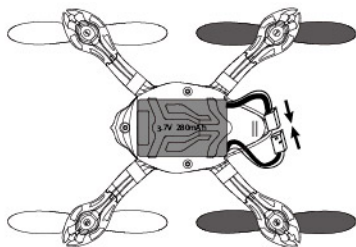

6.1.4 Insert the battery into the bottom of your X4. Make sure the battery and wires are pushed into the end of the battery compartment, so they will not negatively affect the center of gravity and cause unstable flight. **Twist the wires and squeeze them into the notched holder as shown, to prevent shaking when flying.**

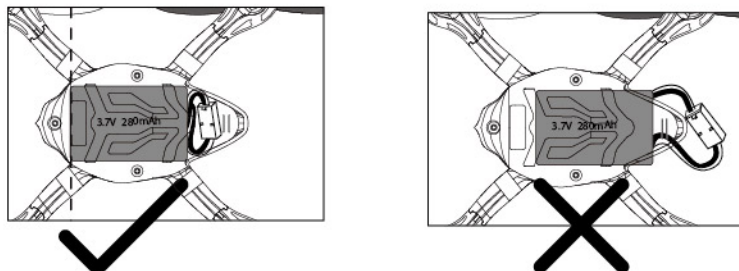

Always disconnect the X4 battery plug after turning off the transmitter when you stop flying.

### 6.1.5 LED Indications

After a “beep”, the red LED on the transmitter turns green, and the 6 lights on the X4 light steadily, indicating successful pairing. Press the lower throttle trim for about 2 seconds to turn the LEDs on or off. **NOTE: The LEDs will automatically blink when the quadcopter battery power is low or the pairing has failed.**

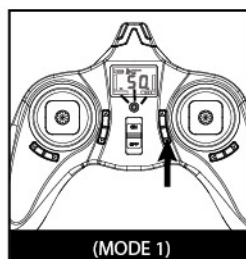
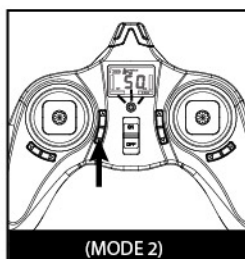

Tip: You do not need to adjust the rudder trim if the X4 keeps yawing left or right during flight. The X4 will find the rudder central point automatically in 3 seconds after the quadcopter lands on a level ground with throttle full down.

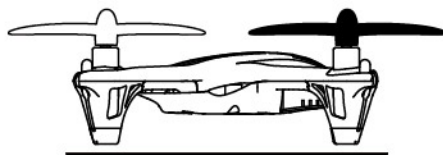

Landing on a level ground

## 6.2 Transmitter Sticks And X4 Control Responses

**CAUTION:** To avoid loss of control, always move the transmitter sticks slowly. Be aware that control inputs will reduce available lift. Be ready to use a little extra throttle to maintain height during maneuvers.

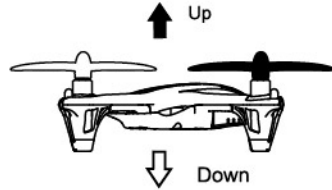
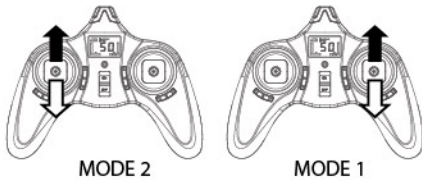

Throttle increases/decreases the flying height of your quadcopter.

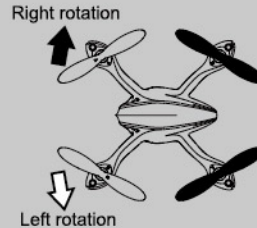
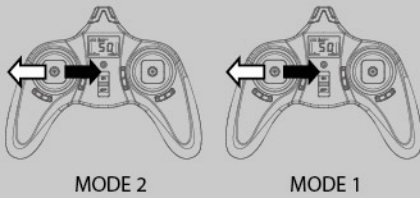

Rudder rotates your quadcopter's fuselage left or right.

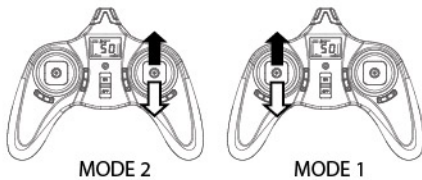

Elevator moves your quadcopter forward and backward.

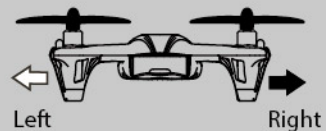
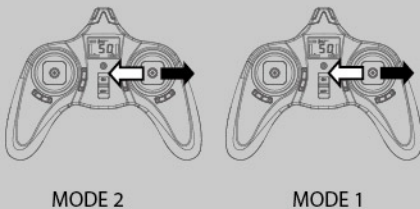

**NOTE:** Controls will *appear reversed* when the model is flying toward you !

Aileron moves your quadcopter left and right.

## 7 ADVANCED PERFORMANCE SETUP

### 7.1 Reverse Setup

#### 7.1.1 Elevator Reverse Setup

Press and hold the Elevator stick for 2 seconds to enter the settings menu. The LCD will display "SE". Press the Elevator Trim up or down to reverse the channel, and then press and hold the Elevator stick for 2 seconds to confirm and exit.

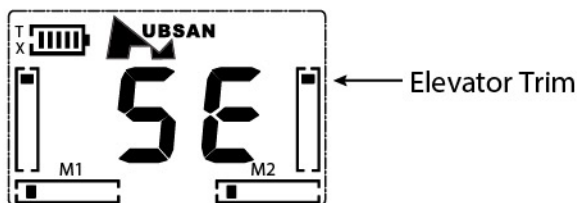

#### 7.1.2 Aileron and Rudder Reverse Setup

Press and hold the Elevator stick for 2 seconds to enter the setting menu. Press (a) Aileron Trim / (b) Rudder Trim left or right to reverse the channel, and then press and hold the Elevator stick for 2 seconds to confirm and exit.

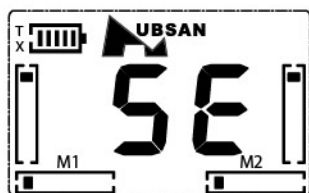

(a) Aileron Trim

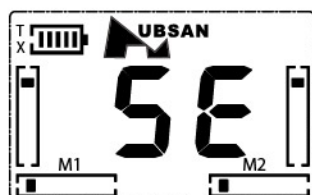

(b) Rudder Trim

### 7.2 Normal and Expert Flight Modes

The X4 is factory set for Normal Mode flying, and it will always power up in Normal Mode. Though fast and responsive in Normal Mode, the X4 has even greater performance capability when Expert Mode is activated.

Press the Elevator stick to activate Expert Mode (the X4 and transmitter must both be on). Two beeps indicate Expert Mode; one beep indicates Normal Mode.

The LCD will display EXPERT and the green LED will blink red and green when in Expert Mode.

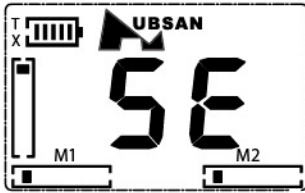

Normal mode



Expert mode

### 7.3 Sensitivity Setup

Hold down the Elevator stick for 2 seconds to enter the setup (SE) menu. Press the base of the throttle stick, the three-point dotted line starts to flash (see picture (a) below). Press it again to switch to different channels. Use the (a) Rudder Trim, (b) Elevator Trim, or (c) Aileron Trim to change the sensitivity values shown on the LCD and then hold down the Elevator stick for 2 seconds to confirm or exit. The X4 control sensitivity increases with higher value settings.

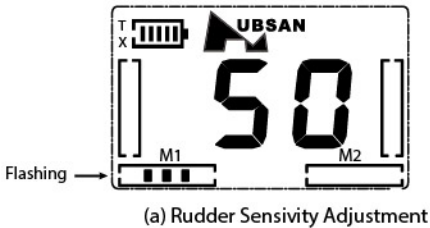
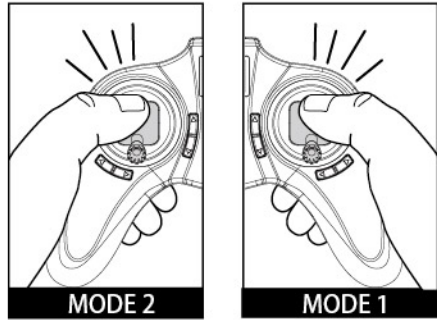

(a) Rudder Sensivity Adjustment

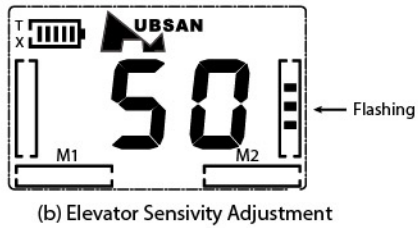

(b) Elevator Sensivity Adjustment

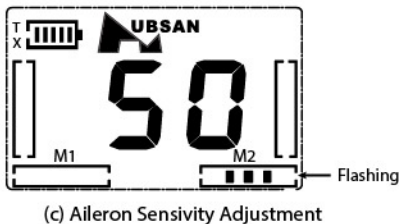

(c) Aileron Sensivity Adjustment



You can also adjust sensitivity in Expert Mode following the Normal Mode procedure controls.

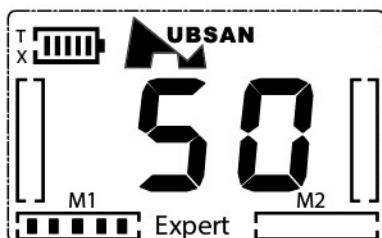

 3 dots displayed in Normal (Sensitivity range 20-60%)

 5 dots displayed in Expert (Sensitivity range 60-100%)

Press the Elevator stick to switch between Normal Mode and Expert Mode at any time.

## 7.4 Aerial Flip Mode

The flip maneuver will only work in Expert Mode.

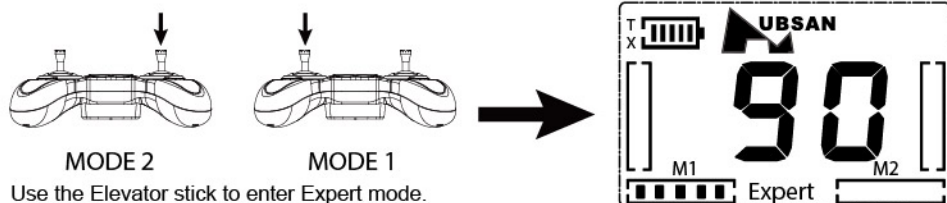

MODE 2

MODE 1

Use the Elevator stick to enter Expert mode.

Press the Throttle stick to enter Flip Mode, indicated by two "beeps".

Press the Throttle stick again to exit Flip Mode, indicated by one "beep".



For proper flip execution, make sure the X4 is close to level, within a 30° angle with the ground, and add throttle to climb before you perform a flip.



### 7.4.1 Left Flip

Push the Aileron stick fully to the right and then quickly push it fully to the left. Release the stick to the center position after the flip.

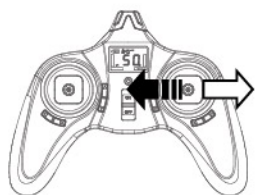

**MODE 2**

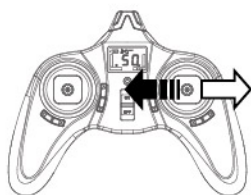

**MODE 1**

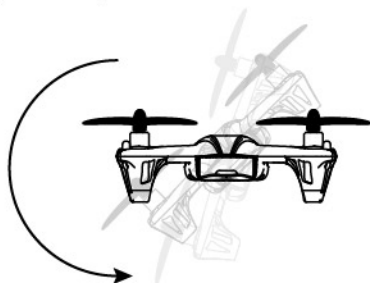

### 7.4.2 Right Flip

Push the Aileron stick fully to the left and then quickly push it fully to the right. Release the stick to the center after the flip.

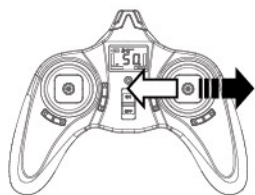

**MODE 2**

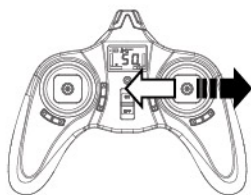

**MODE 1**

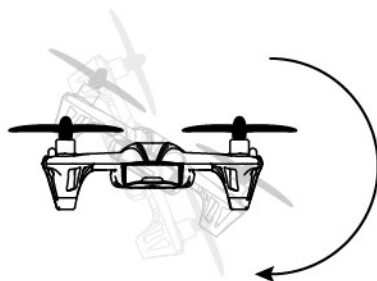

### 7.4.3 Forward Flip

Pull the Elevator stick backward and then quickly push it forward. Release the stick to the center after the flip.

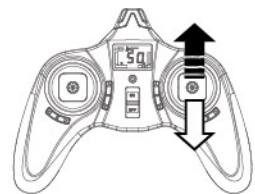

**MODE 2**

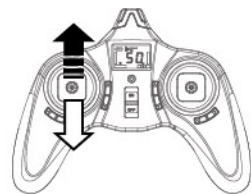

**MODE 1**

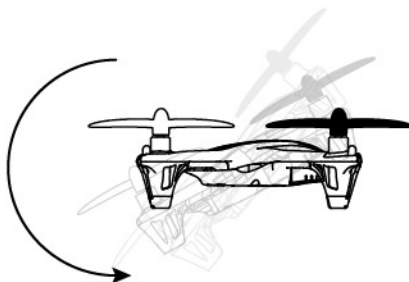

### 7.4.4 Backward Flip

Push the Elevator stick forward and then quickly pull it backward. Release the stick to the center after the flip.

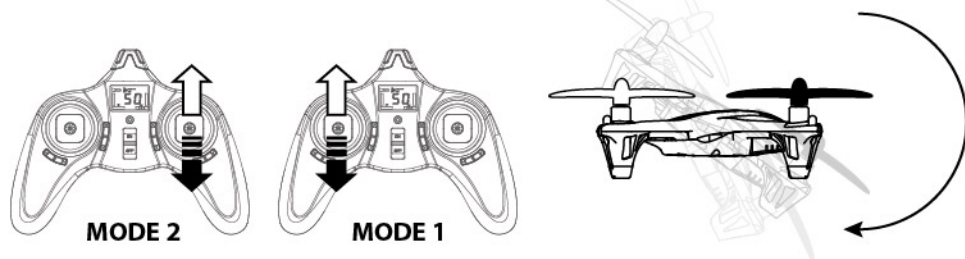

**Note:** when the X4 battery is low, performing flip is not possible.

## 8 REPLACING PROPELLERS

The X4's propellers are not identical. Each propeller is labeled with an A or B. When installing replacement propellers, be certain to install as shown below. The X4 will not fly, and will flip and crash if the propellers are not installed correctly.

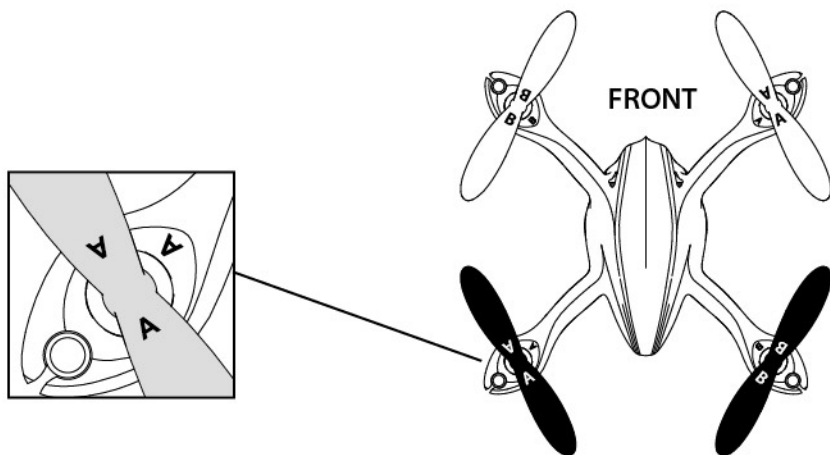

**Remove Propellers:** Hold the propeller, insert the U wrench under the propeller, pull up and the propeller will easily come off the motor shaft.

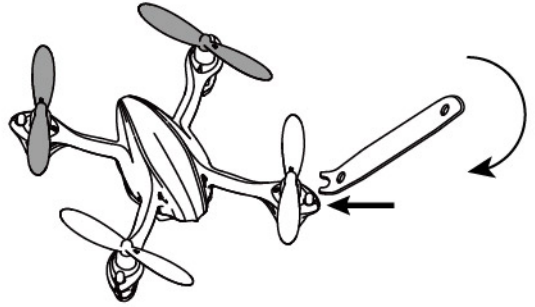

**Install Propellers:** Pinch the propeller hub, align the hole to the motor shaft, and press it straight down firmly but gently.

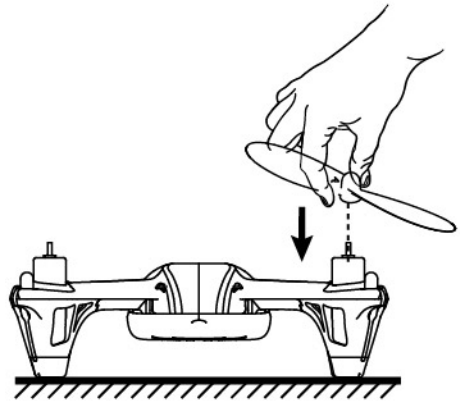

**The propellers are dangerous when the quadcopter is flying. To avoid injury or damage, install the protection cover.**

**Note:**

Remove the propellers. Position the cover's four holes with the motors. Press each of them onto the motors, then re-install the propellers in their correct positions on the X4 .

When removing the protection cover, remove the propellers first as in the above steps, and pinch the protection cover from each motor. After any crash landing, always check to make sure the protection cover is still on tight, and that the body, motors and propellers are not damaged.

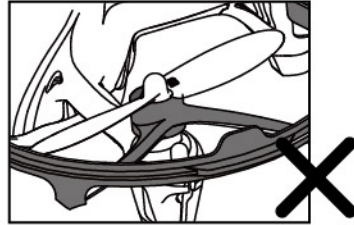
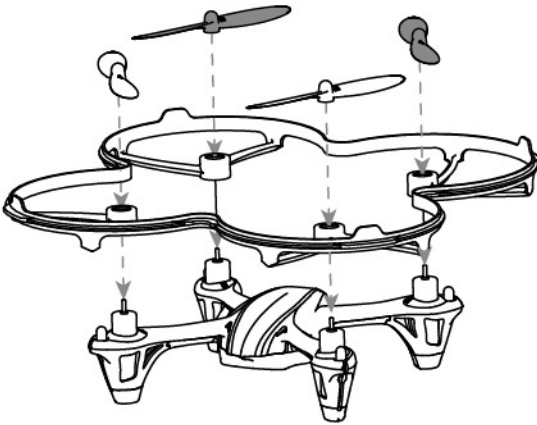

**Attention:** After a crash landing, the protection cover will loose and block the propellers, check and press back the four cover holes before flying again.

## 9. REMOVING AND INSTALLING LEDs

**Removal:** Unscrew and remove the lower shell and the rubber feet. Then desolder the red and yellow wires.

**Installation:** Solder the red wire onto the anode/positive (+) lead of the LED, and the yellow onto the cathode/negative (-) lead of the LED. Press the LED wires into the leg slots, then press the motor wires into the leg slots. Install the lower shell, then the rubber feet. You can determine the color of the LED lights by looking at the color of the LED wire insulation at the bottom of the LED lens: red insulation is the red LED, blue insulation is the blue LED.

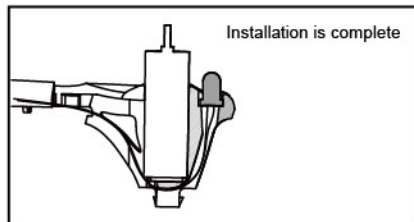
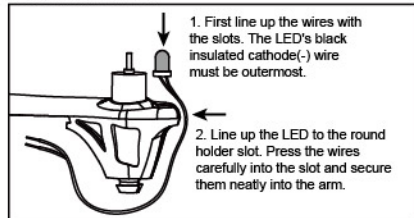
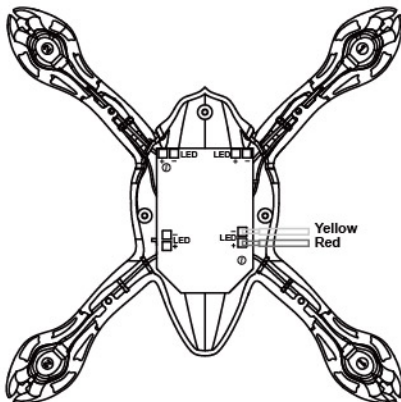

## Exploded View

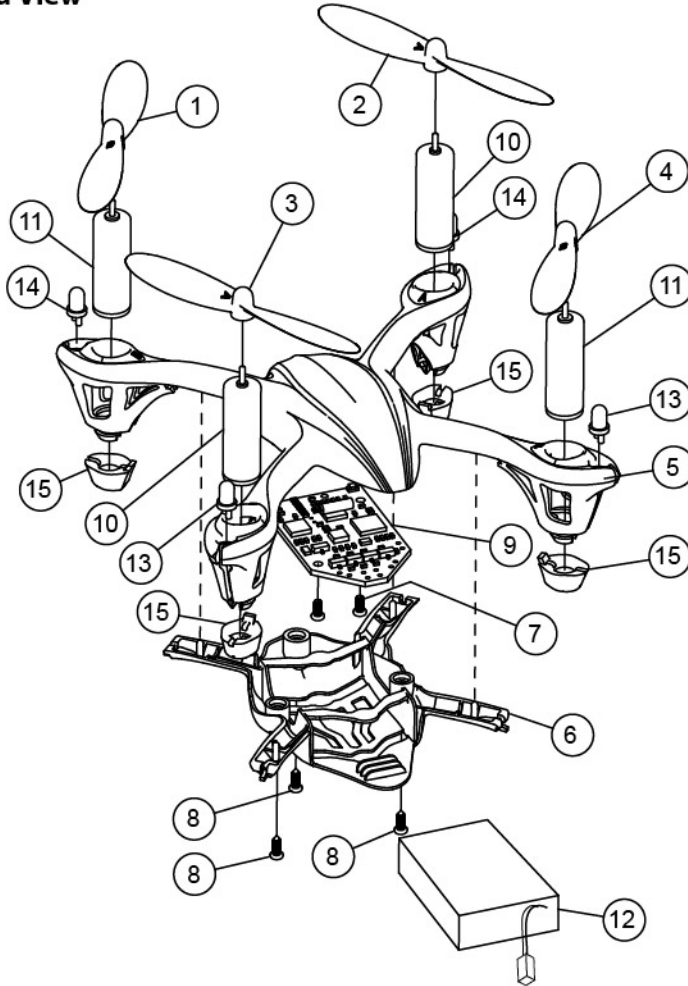

No	PART NAME	QTY	No	PART NAME	QTY
1	White blade B	1	9	RX	1
2	White blade A	1	10	720 motor (clockwise)	2
3	Black blade A	1	11	720 motor (counterclockwise)	2
4	Black blade B	1	12	Li-po battery	1
5	Upper shell	1	13	LED-2	2
6	Lower shell	1	14	LED-1	2
7	Screw	2	15	Rubber feet	4
8	Screw	3			

# H107 TROUBLESHOOTING

1. Transmitter and X4 do not pair.

Throttle stick needs to be in the full down position. Make sure you do not move the transmitter sticks or trim during initial power-on.

2. Transmitter LED suddenly goes out.

Replace the AAA batteries in the transmitter.

3. Transmitter display is not showing the setting interface after holding down the throttle for 2 seconds.

The throttle stick needs to be in the full down position.

4. Gyro is not working well.

(1) Battery voltage is too low.

(2) Pair the X4 with the transmitter again.

(3) Land the X4 with the throttle stick in the full down position for 3 seconds and then take off again.

5. X4 won't perform flips.

(1) Press the Elevator stick to enter into Expert Mode.

(2) In Expert Mode, the sensitivity on each channel should be above 90%. You can program the sensitivity in the Setup Menu. See 7.3 on P13-14.

(3) Press the throttle stick to turn on flip function.

(4) LiPo power is too low. Recharge the X4.

6. Quadcopter is shaking and making noise.

Check that the motors, canopy, body and propellers are all properly positioned.

7. Switching between low and high rates on the transmitter is difficult.

Press the Elevator stick briefly to switch between the Expert Mode (transmitter LED flashes red and green) and Normal Mode (transmitter lights up green steadily). "Expert" will also appear at the bottom center on the display.

8. Cannot take off.

(1) Make sure the propellers are installed correctly. The propellers are marked with "A" (clockwise) and "B" (counterclockwise). Refer to the Top View picture below for the correct orientation.

(2) Make sure that each motor is installed correctly. There are two different motors with different motor wire colors. Refer to the Bottom View picture below for the correct order.

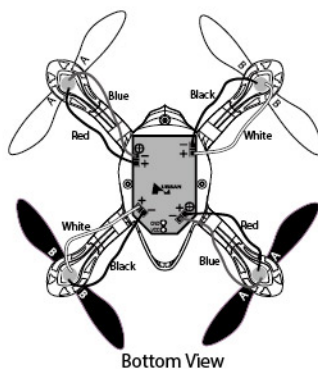
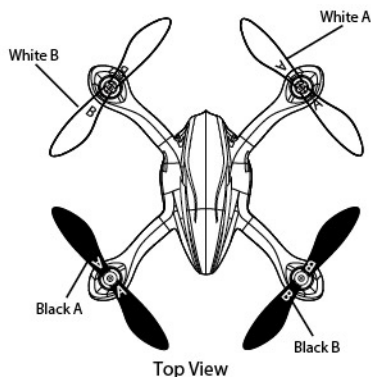



9. The motors do not spin freely after a crash.

Press the shaft down from the top of the propeller and motor to remove any objects, or replace the motor.

10. The arm of the X4 separates after a hard landing or crash.

This is specially designed to absorb impact from hard crashes. Simply force the arms to snap back into the joint position as shown.

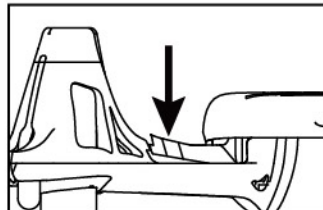

11. One or more motors stop working.

- (1) Replace the motor.
- (2) Resolder any broken motor connections.
- (3) Replace the flight controller.

12. The X4 always drifts to one direction.

Calibrate the accelerometer as follows:

1) Before calibrating the accelerometer, make sure that the propellers, motors and body are in good condition with the battery fully charged. Ensure that the battery and the cables are inserted into the battery compartment correctly (see the picture on P10 6.1.4 ). Pair the X4 and transmitter, then put the X4 in Expert Mode (see P12, 7.2 ).

2) Set both the aileron and elevator trim to the middle so that the LCD displays 50.



**(MODE 1)**



**(MODE 2)**



3) Hold the Throttle stick to the full down position and move the Rudder stick to the lower right position. Quickly move the Aileron stick to the left and right repeatedly until the two headlights blink, indicating successful calibration. This calibration will reduce excessive drifting when doing level yaw turns.

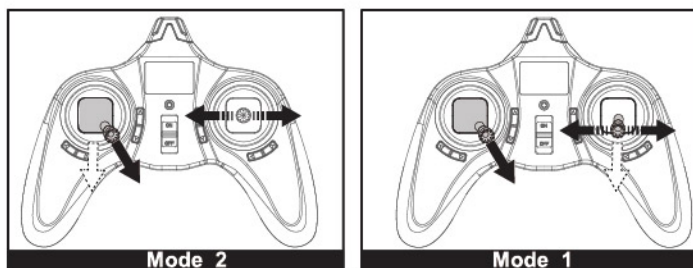

4) If the X4 still drifts to one side, add a few sheets of paper (the number of sheets will vary depending on the amount of drift) to the side of the X4 that drifts. The paper will help counterbalance and create a level offset angle.

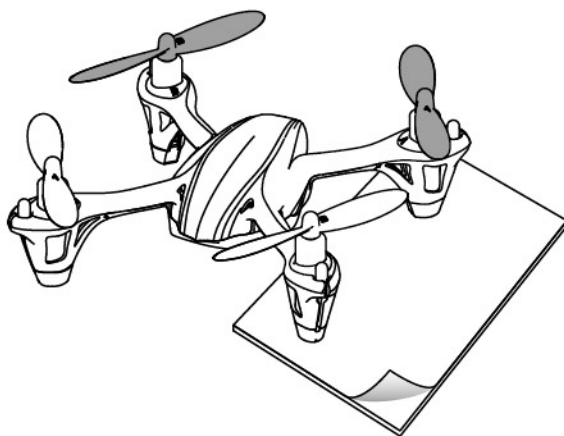

# H107 SPARE PART CHART

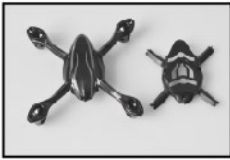

**H107-A31**  
Body Shell



**H107-A02**  
Propellers

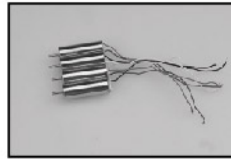

**H107-A03**  
Motor

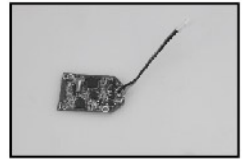

**H107-A34**  
X4 RX



**H107-A05**  
Battery



**H107-A06**  
USB Charger



**H107-A07**  
Screw Set



**H107-16**  
Transmitter



**H107-A39**  
Rubber Feet

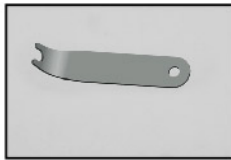

**H107-A11**  
U Wrench



**H107-12**  
Protection Cover



**H107-A13**  
T-Shirt



**H107-A32**  
Blue LEDs

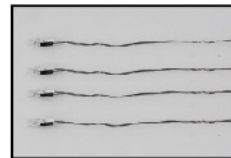

**H107C-A33**  
Red LEDs



**H107-A18**  
Value Pack



**H107-A44**  
4\*AAA Rechargeable  
NI-MH battery (700mAh )

## FCC Information

This equipment has been tested and found to comply with the limits for a Class B digital device, pursuant to Part 15 of the FCC Rules. These limits are designed to provide reasonable protection against harmful interference in a residential installation. This equipment generates, uses, and can radiate radio frequency energy and, if not installed and used in accordance with the instructions, may cause harmful interference to radio communications. However, there is no guarantee that interference will not occur in a particular installation. If this equipment does cause harmful interference to radio or television reception, which can be determined by turning the equipment off and on, the user is encouraged to try to correct the interference by one or more of the following measures:

- Reorient or relocate the receiving antenna.
- Increase the separation between the equipment and receiver.
- Connect the equipment into an outlet on a circuit different from that to which the receiver is connected.
- Consult the local dealer or an experienced radio/TV technician for help.

Changes or modifications not expressly approved by the party responsible for compliance could void the user's authority to operate the equipment.

This device complies with Part 15 of the FCC Rules. Operation is subject to the following two conditions: (1) this device may not cause harmful interference, and (2) this device must accept any interference received, including interference that may cause undesired operation.

# THE HUBSAN X4

2.4GHZ RC SERIES 4 CHANNEL