

# MONOPRICE

## MP Strata Vacuum 2.0



P/N 21714

## User's Manual

# CONTENTS

SAFETY WARNINGS AND GUIDELINES .....	4
INTRODUCTION.....	5
FEATURES.....	5
CUSTOMER SERVICE.....	5
PACKAGE CONTENTS .....	6
PRODUCT OVERVIEW.....	7
Vacuum.....	7
Roller Brush Attachment.....	8
Charging Station.....	8
Remote Control.....	9
Display/Control Panel.....	10
OPERATING MODES.....	11
Normal Cleaning Mode.....	11
Spot Cleaning Mode .....	11
Edge Cleaning Mode .....	12
Schedule Mode.....	12
SETUP AND CHARGING .....	12
OPERATION.....	14
Power On/Off.....	14
Standby and Sleep Modes .....	14
Cleaning.....	14
CLEANING MODES.....	15
SCHEDULING.....	17
Setting the Clock .....	17
Setting the Scheduled Time.....	17
Clearing the Schedule Time.....	18

USING THE MOPPING ATTACHMENT.....	19
CHANGING ATTACHMENTS.....	19
USING THE VIRTUAL WALL .....	20
MAINTENANCE.....	20
Cleaning the Dust Bin and Filters.....	20
Clean the Side Brushes.....	22
Cleaning Sensors and Wheels .....	22
Cleaning the Charging Poles .....	22
Cleaning the Suction Passage and Dust Sensor .....	23
Cleaning the Roller Brush Attachment.....	23
TROUBLESHOOTING .....	25
TECHNICAL SUPPORT.....	29
SPECIFICATIONS.....	30
REGULATORY COMPLIANCE .....	30
Notice for FCC .....	30

## SAFETY WARNINGS AND GUIDELINES

Please read this entire manual before using this device, paying extra attention to these safety warnings and guidelines. Please keep this manual in a safe place for future reference.

- This device is intended for indoor use only.
- Do not use this device in a wet or moist environment, such as a bathroom or laundry.
- Do not touch the device, the power cord, or any other connected cables with wet hands.
- Do not expose this device to excessively high temperatures. Do not place it in, on, or near heat sources, such as a fireplace, stove, radiator, etc. Do not leave it in direct sunlight.
- Do not use this vacuum in proximity to curtains, cords, loose cables, fragile objects, papers, loose debris, or anything that could get easily knocked over.
- Do not use this vacuum around cigarette ends, lighters, matches, volatile liquids such as gasoline, or any other flammable materials.
- If the vacuum needs to be cleaned, it should be fully charged beforehand.
- Do not sit on the vacuum or allow pets or children to sit on it. Take care when using this around children or pets.
- Do not use this product where it can easily fall, such as on tables, chairs, or next to stairs.
- Turn off the vacuum when transporting it or when it will not be used for a long time.
- Empty and clean the dust bin and filters after each use.
- Remove the batteries from the remote if it will be unused for a long time.
- Fully charge the battery before first use and at least once every three months.
- This device contains a rechargeable battery. Dispose of the device or battery only in accordance with local, state, or federal regulations for electronic waste.
- Do not allow small children to use or play with this vacuum.

## INTRODUCTION

Experience the best of both worlds with the MP Strata Vacuum 2.0. Featuring high power suction in a sleek (3.46" tall) design, it is ready to tackle pet hair, hardwood floors, and carpets. The large (0.5 liter) dust bin is washable and includes a preinstalled HEPA filter. The MP Strata Vacuum 2.0 includes a charging dock for automated charging. It remembers its charging location and quickly finds its way home when the battery level is low or when cleaning is complete. It can clean continuously for up to 100 minutes, ensuring that it gets the job done the first time. Featuring four distinct cleaning modes, the vacuum automatically detects and adjusts its operation based on the floor type, the amount of open space, and the presence of obstacles for a truly automated cleaning experience.

## FEATURES

- Powerful suction ensures that even tiny dust is thoroughly cleaned
- Swappable roller-brush and vacuum suction kits
- Includes mopping pad and water tank attachment
- Automatically adjusts the suction power based on the type of floor detected
- One button start
- Washable dust bin
- Four cleaning modes

## CUSTOMER SERVICE

The Monoprice Customer Service department is dedicated to ensuring that your ordering, purchasing, and delivery experience is second to none. If you have any problem with your order, please give us an opportunity to make it right. You can contact a Monoprice Customer Service representative through the Live Chat link on our website [www.monoprice.com](http://www.monoprice.com) during normal business hours (Mon-Fri: 5am-7pm PT, Sat-Sun: 9am-6pm PT) or via email at [support@monoprice.com](mailto:support@monoprice.com)

## PACKAGE CONTENTS

Please take an inventory of the package contents to ensure you have all the items listed below. If anything is missing or damaged, please contact Monoprice Customer Service for a replacement.

- 1x Strata Vacuum 2.0 with installed Suction Attachment, Dust Bin, and HEPA Filter
- 1x Charging Station
- 1x AC Power Adapter
- 1x Remote Control
- 1x Roller Brush Attachment
- 1x Mopping Pad and Water Tank Attachment
- 1x Virtual Wall
- 1x Spare HEPA Filter
- 1x Double-ended Cleaning Brush
- 2x Left Side Brushes
- 2x Right Side Brushes
- 1x User's Manual

# PRODUCT OVERVIEW

## Vacuum

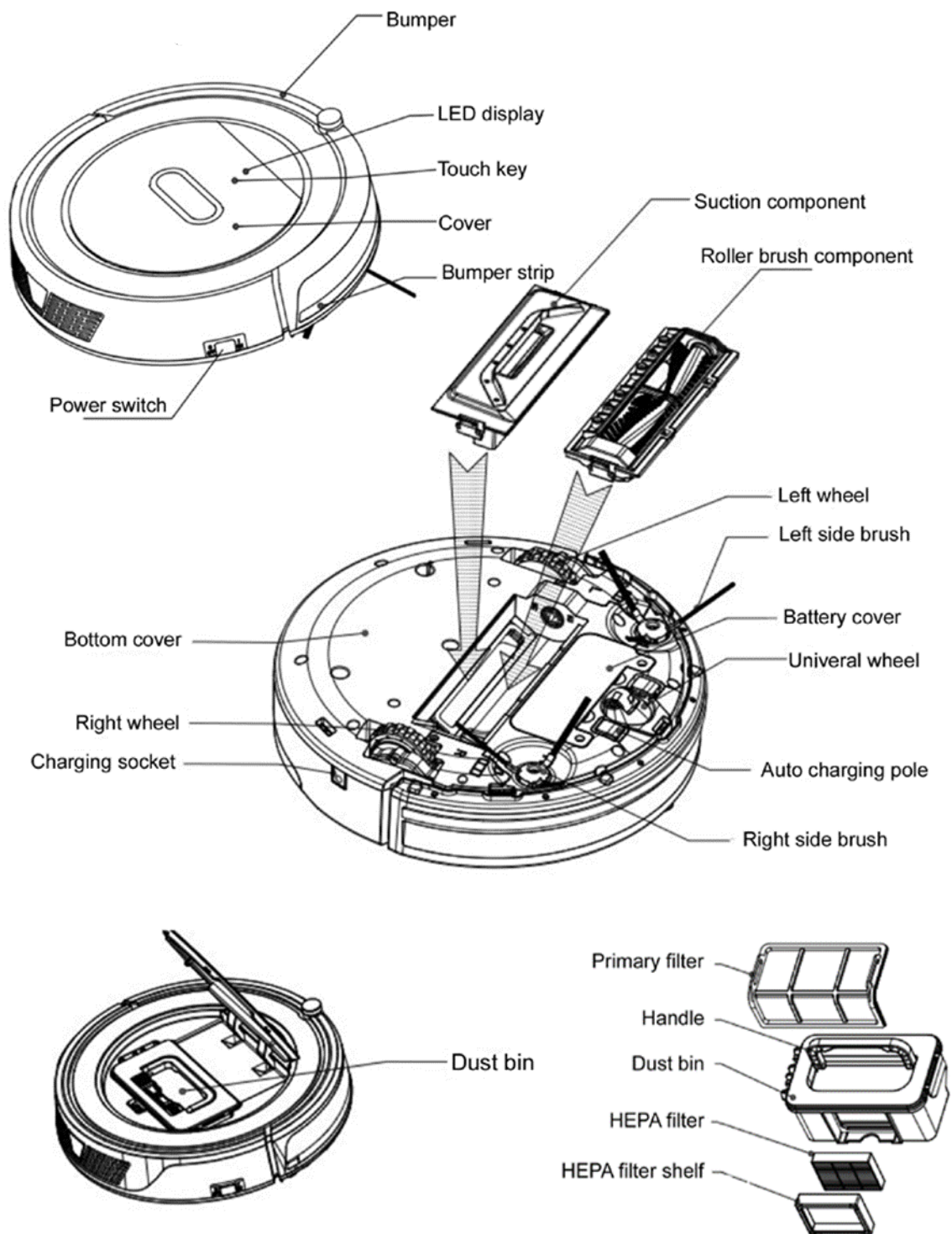

## Roller Brush Attachment

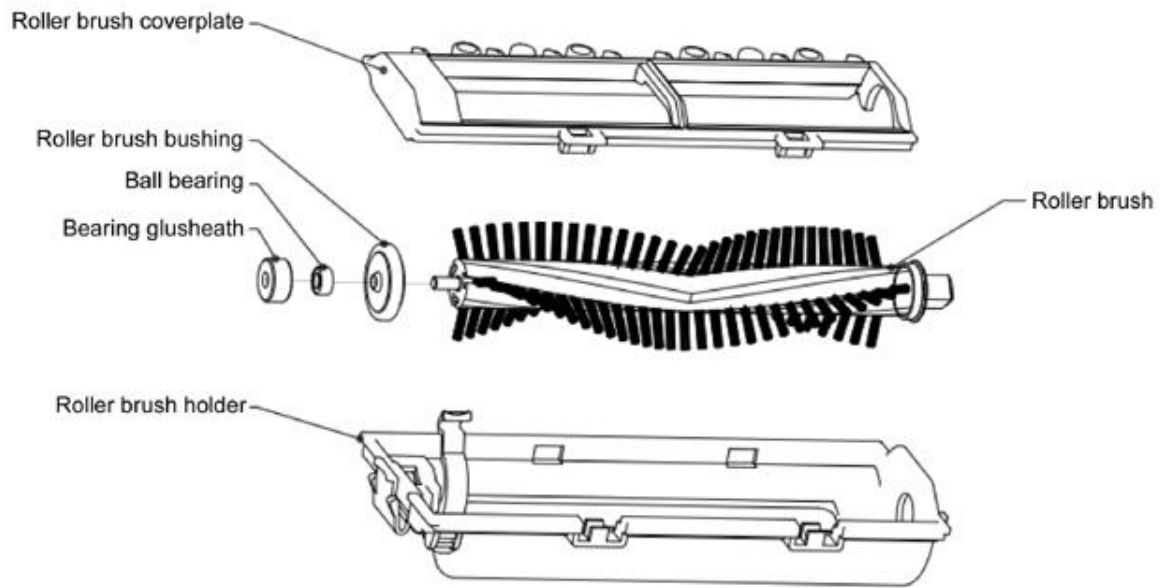

## Charging Station

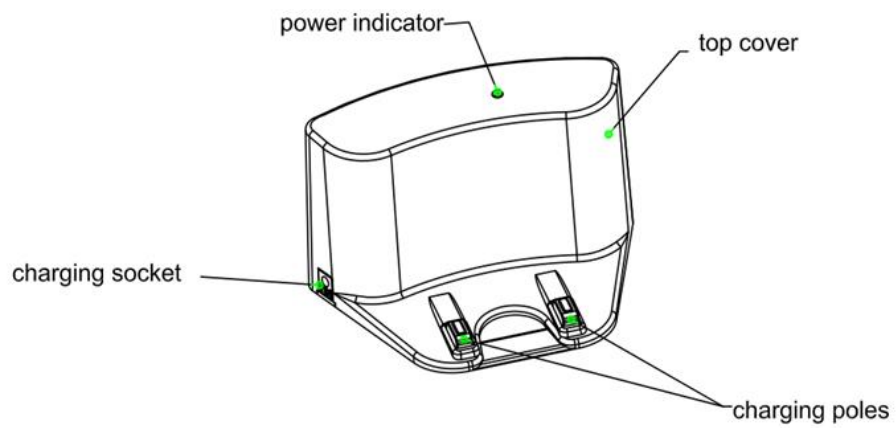



## Remote Control

1. **ON/OFF Button (Clean):** With the vacuum in **Standby** mode, press the **ON/OFF** button to start or stop cleaning.
2. **Directional Buttons:** While cleaning is in progress, press the directional buttons to alter the vacuum's path. The left and right buttons will cause the vacuum to turn in those directions, the forward button will cause the vacuum to move forward and the back button causes it to back up. The center button has no effect.
3. **SPOT Button:** Press the **SPOT** button to cause the vacuum to enter **Spot Cleaning** mode in its current location. The vacuum will automatically re-enter **Normal Cleaning** mode when the **Spot Cleaning** is finished. Alternatively, use the directional buttons to re-enter **Normal Cleaning** mode or stop cleaning by pressing the **ON/OFF** button.
4. **HOME Button:** Press the **HOME** button to cause the vacuum to return to the Charging Station to begin charging.
5. **MODE Button:** Press the **MODE** button to cycle through the four cleaning modes.

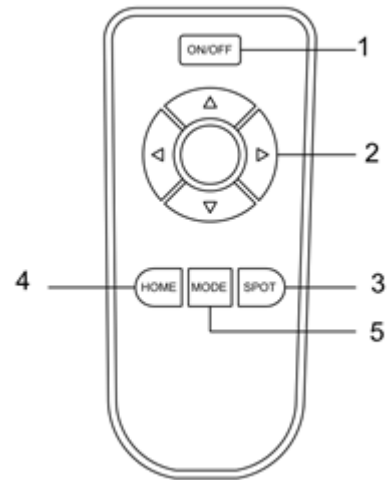

*Note: Insert two AAA batteries (not included) into the remote control's battery compartment prior to use. Remove the batteries if the remote will go unused for a long period of time. Note that the remote control may not function properly near the charging station.*

## Display/Control Panel

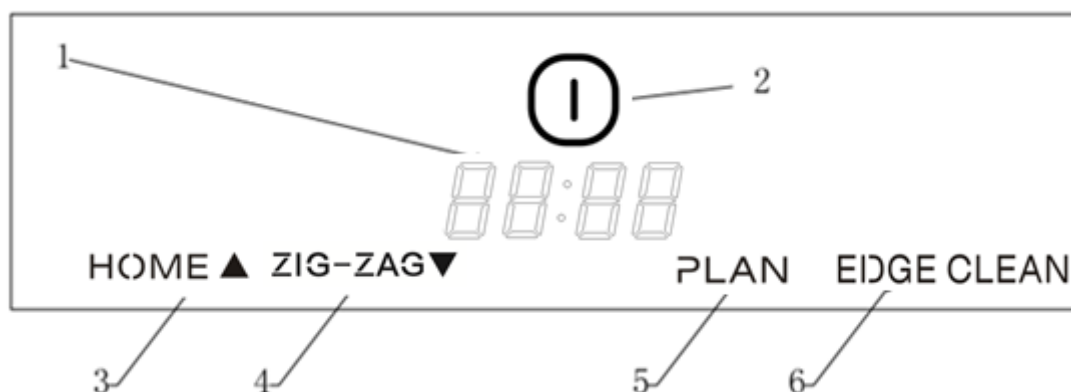

1. **88:88** : The **LED Panel** displays the Time Setting, Charging Status, and Error Codes, using numbers, letters, or graphs. Non-error code displays are:

**FULL**: The battery is fully charged.

**[ ] ] ]**: The battery charge is low.

**11:11**: The battery is being charged.

**RUBF**: The suction passage is blocked.

**RUBN**: The dust bin is no installed.

2. **①**: The **①** button performs the following functions.
  - A: Press the button to change from **Sleep** mode to **Standby** mode.
  - B: When in **Standby** mode, press and hold the button for 3 seconds to go into **Sleep** mode.
  - C: When in **Scheduling** mode, press the button to confirm the schedule setting.
  - D: When in **Standby** mode, press the button to start **Normal Cleaning** mode.
3. **HOME ▲**: The **HOME ▲** button performs the following functions:
  - A: When in **Scheduling** mode, press the button to increase the displayed value.
  - B: When in any mode except **Scheduling** mode, press the button to start **Auto-Homing** and **Charging** modes.

4. **ZIG-ZAG ▼**: The **ZIG-ZAG ▼** button performs the following functions:
  - A: When in **Scheduling** mode, press the button to decrease the displayed value.
  - B: When in any mode except **Scheduling** mode, press the button to begin the **Zig-Zag Cleaning** mode.
5. **PLAN**: Press the **PLAN** button to enter or exit **Scheduling** mode.
6. **EDGE CLEAN**: When in **Standby** mode, press the **ZIG-ZAG ▼** button to begin **Edge Cleaning** mode.
7. **PUSH**: Press the **PUSH** button to open the top cover.

## OPERATING MODES

### Normal Cleaning Mode

The **Normal Cleaning** mode is an automatic mode in which the vacuum automatically switches between the three types of cleaning paths. Normally, when in a room with few obstacles, it will clean the floor using a Zig-Zag path, as shown in the diagram. When it detects a particularly dirty spot, it will switch to **Spot Cleaning** mode and when it detects obstacles, it will switch to **Edge Cleaning** mode. When cleaning is in progress, the LED display shows the current time.



### Spot Cleaning Mode

The vacuum will clean intensively in a spiral-shaped cleaning pattern when it detects a very dirty area or when the **Spot Cleaning** mode is manually activated.



## Edge Cleaning Mode

The vacuum cleans along walls and obstacles when it detects a wall or obstacle or when the **Edge Cleaning** mode is manually activated.

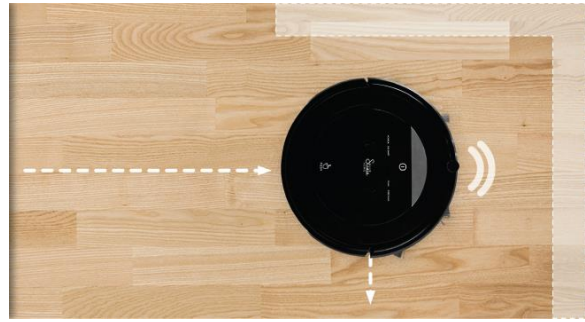

## Schedule Mode

Once a cleaning schedule time has been set, the vacuum will automatically start cleaning in **Normal Cleaning** mode at the scheduled time.



## SETUP AND CHARGING

1. Position the Charging Station against a wall near an AC outlet and with at least 1 meter (3 feet) of space on each side and 2 meters (6 feet) of space to the front.
2. Ensure that the **Power Switch** on the side of the vacuum is in the **OFF** position.
3. Insert the DC barrel connector on the included **AC Power Adapter** into the **Charging Socket** on the **Charging Station**, then plug the adapter into a nearby AC power outlet.
4. Flip the **Power Switch** on the side of the vacuum to the **ON** position, then place the vacuum on the floor.

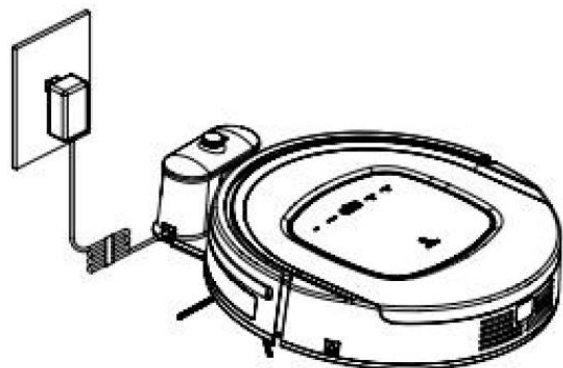
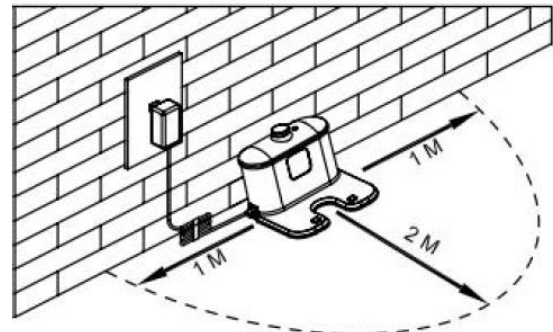

5. Press the **HOME ▲** button on the vacuum or the **HOME** button on the included remote control. The vacuum will automatically position itself against the power station and charging will begin. While charging is in progress, the LED display on the **Display/Control Panel** will show a series of 1s (**1111**), from left to right. When charging is complete, the LED display will show **FULL**.

**Notes:**

- Fully charge the battery for 12 hours prior to first use.
- Charge the battery for 12 hours at least once every three months.
- If the vacuum will go unused for more than three months or for any long period of time, charge the battery for 12 hours, then flip the **Power Switch** to the **OFF** position and store it in a cool, dry place.
- When the vacuum is in **Standby** mode and the battery level is low, it will broadcast the voice message **Please Charge** and the display shows **[ ] ] ]**.
- You can charge the vacuum directly, without using the **Charging Station**, by plugging the included **AC Power Adapter** into the **Charging Socket** on the vacuum.
- When the vacuum is in operation, it will automatically return to the **Charging Station** and begin recharging when the battery level is low.
- The vacuum will automatically return to the **Charging Station** and begin charging when it is finished cleaning.

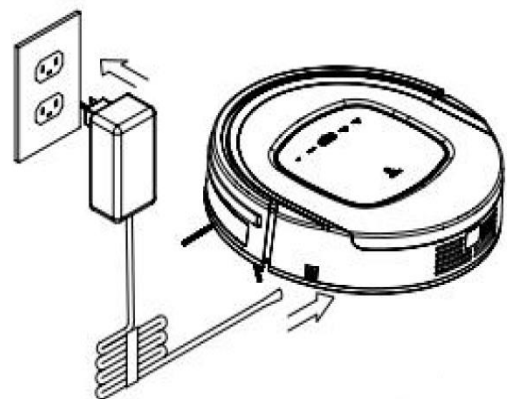



# OPERATION

## Power On/Off



- Flip the **Power Switch** on the right side of the vacuum to power it on or off. While powered on and not in actual operation, the vacuum can be placed in **Sleep** or **Standby** mode.

## Standby and Sleep Modes

- The vacuum must be powered on to enter **Standby** or **Sleep** mode.
- The LED display is illuminated when the vacuum is in **Standby** mode and is off when it is in **Sleep** mode.
- When the vacuum is in **Sleep** mode, press the  button on the vacuum or the **ON/OFF** button on the remote control once to enter **Standby** mode.
- While cleaning is in progress, press the  button on the vacuum or the **ON/OFF** button on the remote control to enter **Standby** mode.
- When the vacuum is in **Standby** mode, press and hold the  button for about three seconds to enter **Sleep** mode.
- When the vacuum is in **Standby** mode, it will automatically enter **Sleep** mode if no buttons are pressed for 60 seconds.

## Cleaning

Perform the following steps to manually begin cleaning.

1. Ensure that the **Power Switch** on the side of the vacuum is in the on position.
2. Press the  button on the vacuum to enter **Standby** mode. If the vacuum is on the charger it will begin cleaning right away in **Normal Cleaning** mode. Otherwise, press the  button again to begin cleaning.
3. While cleaning is in progress, use the remote control to control the vacuum's cleaning behavior.

- Press the **ON/OFF** button on the remote control to stop cleaning and re-enter **Standby** mode. Press it again to start **Normal Cleaning** mode again.
- Press the **MODE** button on the remote control to cycle through **Normal Cleaning**, **Spot Cleaning**, and **Edge Cleaning** modes.
- Press the **SPOT** button on the remote control to immediately enter **Spot Cleaning** mode. After it is finished cleaning the spot, the vacuum will automatically re-enter **Normal Cleaning** mode.
- Press the **ON/OFF** button on the remote control to cause the vacuum to return to the **Charging Station** to begin charging.
- While in any cleaning mode, use the **Directional** buttons on the remote to alter the vacuum's cleaning path. Use the left and right buttons to change the path to the left or right. Use the back button to cause the vacuum to back up. Use the forward button to straighten out the vacuum's cleaning path. The center button has no function.
- When cleaning is complete or when the battery level is low, the vacuum will automatically return to the **Charging Station** to begin charging.

## CLEANING MODES

1. **Auto Cleaning:** The **Auto Cleaning** mode cleans the room using a variety of automatically selected cleaning modes. Press the  mode on the vacuum or the **ON/OFF** button on the remote control to start **Auto Cleaning** mode. You can also select **Auto Cleaning** mode by pressing the **MODE** button on the remote control to cycle through the four cleaning modes. The **LED Panel** will show **2222** when in **Auto Cleaning** mode.

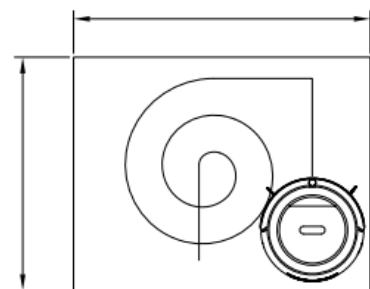

2. **Spot Cleaning:** The **Spot Cleaning** mode is designed to repeatedly clean a particularly dirty spot on the floor. The vacuum will automatically enter **Spot Cleaning** mode when it detects a particularly dirty spot on the floor. You can manually select **Spot Cleaning** mode

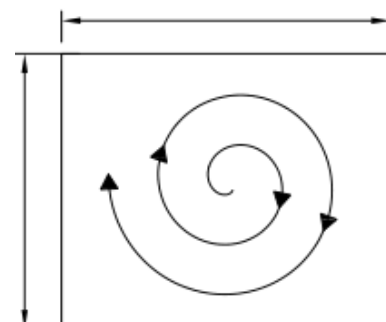

by pressing the **SPOT** button on the remote control. You can also select **Spot Cleaning** mode by pressing the **MODE** button on the remote control to cycle through the four cleaning modes. The **LED Panel** will show **1111** when in **Spot Cleaning** mode.

3. **Edge Cleaning:** The **Edge Cleaning** mode is designed to clean along a wall or around other obstacles. The vacuum will automatically enter **Edge Cleaning** mode when it encounters a wall or other obstacle. You can manually select **Edge Cleaning** mode by pressing the

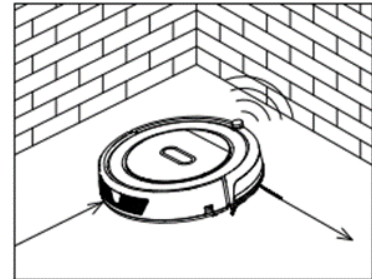

**EDGE CLEAN** button on the vacuum. You can also select **Edge Cleaning** mode by pressing the **MODE** button on the remote control to cycle through the four cleaning modes. The **LED Panel** will show **3333** when in **Edge Cleaning** mode.

4. **Zig-Zag Cleaning:** The Zig-Zag Cleaning mode is one in which the vacuum uses long, parallel cleaning paths. The vacuum automatically enters Zig-Zag Cleaning mode whenever it detects a large, open area. You can manually select the Zig-Zag Cleaning mode by pressing the **ZIG-ZAG ▼** button on the

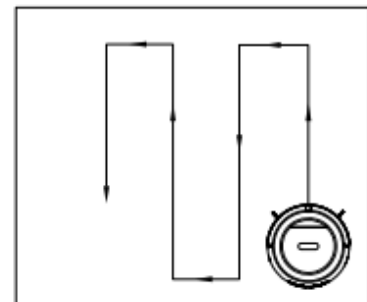



vacuum. You can also select **Zig-Zag Cleaning** mode by pressing the **MODE** button on the remote control to cycle through the four cleaning modes. The **LED Panel** will show **4444** when in **Zig-Zag Cleaning** mode.



## SCHEDULING



### Setting the Clock

Prior to scheduling, the vacuum's clock should be set to the current time. Perform the following steps to set the clock.

1. Ensure that the vacuum is in **Standby** mode or is charging. If it is in **Sleep** mode, press the  button on the vacuum to enter **Standby** mode. If the vacuum is actively cleaning, press the **ON/OFF** button on the remote control to stop cleaning and enter **Standby** mode.
2. Press the **PLAN** button on the vacuum to enter Clock Setting mode. The clock's hour display will start to flash.
3. Press the **HOME ▲** button on the vacuum to increase the hour value or press the **ZIG-ZAG ▼** button on the vacuum to decrease it.
4. Press the  button on the vacuum to confirm the hour setting. The clock's minute display will start flashing.
5. Press the **HOME ▲** button on the vacuum to increase the minute value or press the **ZIG-ZAG ▼** button on the vacuum to decrease it.
6. Press the  button on the vacuum to confirm the minute setting.
7. Press the **PLAN** button on the vacuum to exit Clock Setting mode.

### Setting the Scheduled Time

Perform the following steps to set the time at which the vacuum will begin automatic cleaning.

1. Ensure that the vacuum is in **Standby** mode or is charging. If it is in **Sleep** mode, press the  button on the vacuum to enter **Standby** mode. If the vacuum is actively cleaning, press the  button on the remote control to stop cleaning and enter **Standby** mode.
2. If the clock has not yet been set, set it by following the instructions in the *Setting the Clock* section.

3. Press and hold the **PLAN** button on the vacuum for two seconds, then release the button to enter Scheduling Mode. The LED display will show either the currently set scheduled time or 00:00 if no scheduled time is set. The hour value will be flashing.
4. Press the **HOME ▲** button on the vacuum to increase the hour value or press the **ZIG-ZAG ▼** button on the vacuum to decrease it.
5. Press the **ⓘ** button on the vacuum to confirm. The minute value will begin flashing.
6. Press the **HOME ▲** button on the vacuum to increase the minute value or press the **ZIG-ZAG ▼** button on the vacuum to decrease it.
7. Press the **ⓘ** button on the vacuum to confirm the minute setting.
8. Press the **PLAN** button on the vacuum to exit Clock Setting mode.

## Clearing the Schedule Time

Perform the following steps to clear the scheduled time.

1. Press and hold the **PLAN** button on the vacuum to enter Scheduling mode. The hour value will begin flashing.
2. Use the **HOME ▲** or **ZIG-ZAG ▼** button on the vacuum to set the hour value to **00**.
3. Press the **ⓘ** button on the vacuum to confirm the hour setting. The minute value will begin flashing.
4. Use the **HOME ▲** or **ZIG-ZAG ▼** button on the vacuum to set the minute value to **00**.
5. Press the **ⓘ** button on the vacuum to confirm the minute setting.
6. Press the **PLAN** button on the vacuum to exit Clock Setting mode.

## USING THE MOPPING ATTACHMENT

Perform the following steps to use the included Mopping Pad and Water Tank Attachment.

1. If the **Mopping Pad** has been removed from the **Water Tank**, attach it to the **Water Tank**. The **Water Tank** has hook and loop pads that allow the **Mopping Pad** to stay attached.
2. Remove the **Rubber Cap** from the **Water Tank** and fill it with water. Reattach the **Rubber Cap**.
3. Align the four posts on the **Water Tank** with the holes in the bottom of the vacuum, then press it firmly into place.

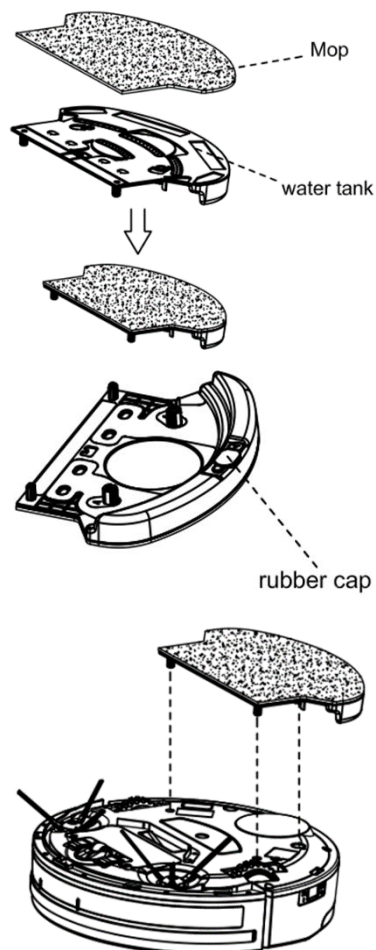

## CHANGING ATTACHMENTS

By default, the vacuum ships with the suction attachment installed. Perform the following steps to swap the suction and roller brush attachments.

1. Ensure that the **Power Switch** on the vacuum is in the off position.
2. Invert the vacuum so that it rests on its top. Orient it so that the universal wheel is away from you.
3. Press the locking tab on the right side of the attachment to release it from the vacuum body, then lift it out of the compartment.
4. Insert the tabs on the left side of the attachment into the holes inside the compartment, then press down on the right side to click it into place.

## USING THE VIRTUAL WALL

The Virtual Wall allows you to create a virtual barrier, beyond which the vacuum will not go. Perform the following steps to use the Virtual Wall.

1. Release the latch on the bottom of the Virtual Wall, then remove the battery cover.
2. Insert two D batteries (not included) into the battery compartment. Ensure that the polarity of the exposed ends of the batteries match the adjacent polarity markings.
3. Replace the battery cover and latch it into place.
4. Place the Virtual Wall on the floor with the hole on the side and the arrow on the top pointed towards the opposite wall.
5. Slide the power switch on the Virtual Wall to the on position.

## MAINTENANCE

The following cleaning and maintenance procedures should be performed periodically, as directed in each section.

### Cleaning the Dust Bin and Filters

Thoroughly clean the Dust Bin and the filters after each use.

1. Ensure that the **Power Switch** on the vacuum is in the off position.

2. Press the  **PUSH** area on the top cover to unlatch it, then open the cover.

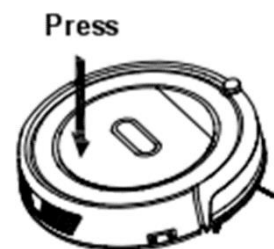

3. Use the handle to lift the Dust Bin out of the compartment.



4. Use your thumb to pry the rubber lip at the bottom of the HEPA filter to remove it from the Dust Bin.



5. Remove the brush from the top of the Dust Bin lid.

6. Use your thumb to release the latch on the side of the Dust Bin, then swing the lid open.

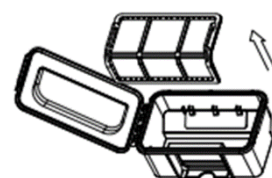

7. Remove the primary filter.



8. Empty the Dust Bin to the trash.

9. Using warm water and a mild soap, thoroughly wash the Dust Bin.



10. Using warm water and the included cleaning brush, thoroughly clean the primary filter.



11. Use the brush to thoroughly clean the HEPA filter.

12. Thoroughly dry or allow all parts to thoroughly dry before reassembly. This is especially important for the filters.

13. Insert the primary filter into the Dust Bin, then close the lid.

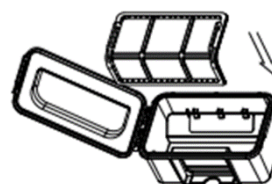

14. Reinstall the brush onto the retaining clips on the Dust Bin lid.

15. Reinstall the HEPA filter onto the side of the Dust Bin.

16. Insert the Dust Bin into the vacuum.

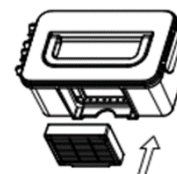

17. Close the lid, then press the  area to latch it into place.

*Note: If you notice a loss in suction power, the HEPA filter may need to be cleaned with warm water. The HEPA filter should be replaced after two washes with water.*

## Clean the Side Brushes

After each use, inspect the side brushes and clean as necessary. Replace the side brushes when they are damaged after 12 months, whichever comes first. When replacing the brushes, match the L/R markings on the brushes with the L/R markings on the bottom of the vacuum.

## Cleaning Sensors and Wheels

After each use, wipe the sensors and wheels clean with a soft, dry cloth, at the indicated locations.

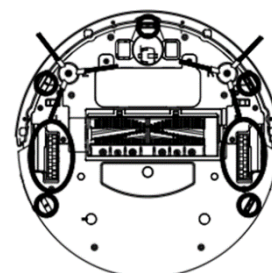

## Cleaning the Charging Poles

Periodically wipe the charging poles clean on the Charging Station and Vacuum with a soft, dry cloth.

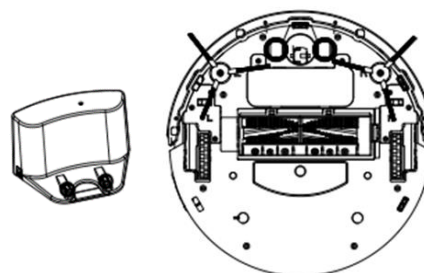

## Cleaning the Suction Passage and Dust Sensor

After each use, remove the Suction Attachment and clean the suction passage and dust sensors with a soft, dry cloth. Do not allow the sensors to get wet!

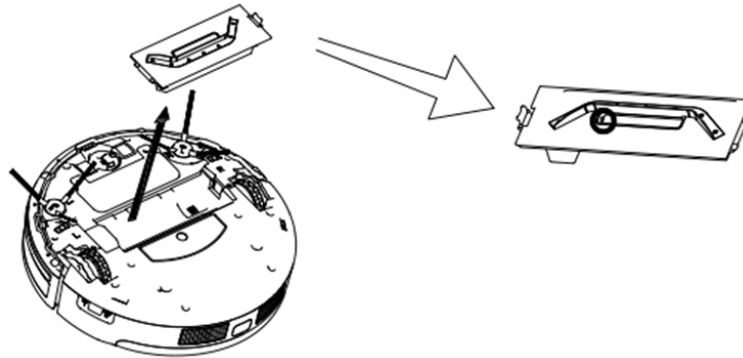

## Cleaning the Roller Brush Attachment

Periodically clean the Roller Brush Attachment using warm water. Perform the following steps to disassemble the Roller Brush Attachment for cleaning.

1. Remove the Roller Brush Attachment from the vacuum.
2. Position the Roller Brush Attachment with the rubber lip away from you.
3. Locate the two tabs on the side closest to you. Notice that there is an outer tab and an inner table. Insert the blade of a small flat head screwdriver into the small gap between the outside tab and the roller brush coverplate, then press gently on the inner tab to release it. Repeat for the other set of tabs, then remove the coverplate.
4. Locate the tab on the top, left side of the retaining ring, then pull it to release it. Swing the retaining ring out of place.
5. Remove the roller brush.
6. Thoroughly wash the roller brush with warm water. Pull out any hair or other debris from the brushes.
7. Clean the plastic parts with warm water and mild soap.
8. Reassemble the Roller Brush Attachment only after all parts have thoroughly dried.

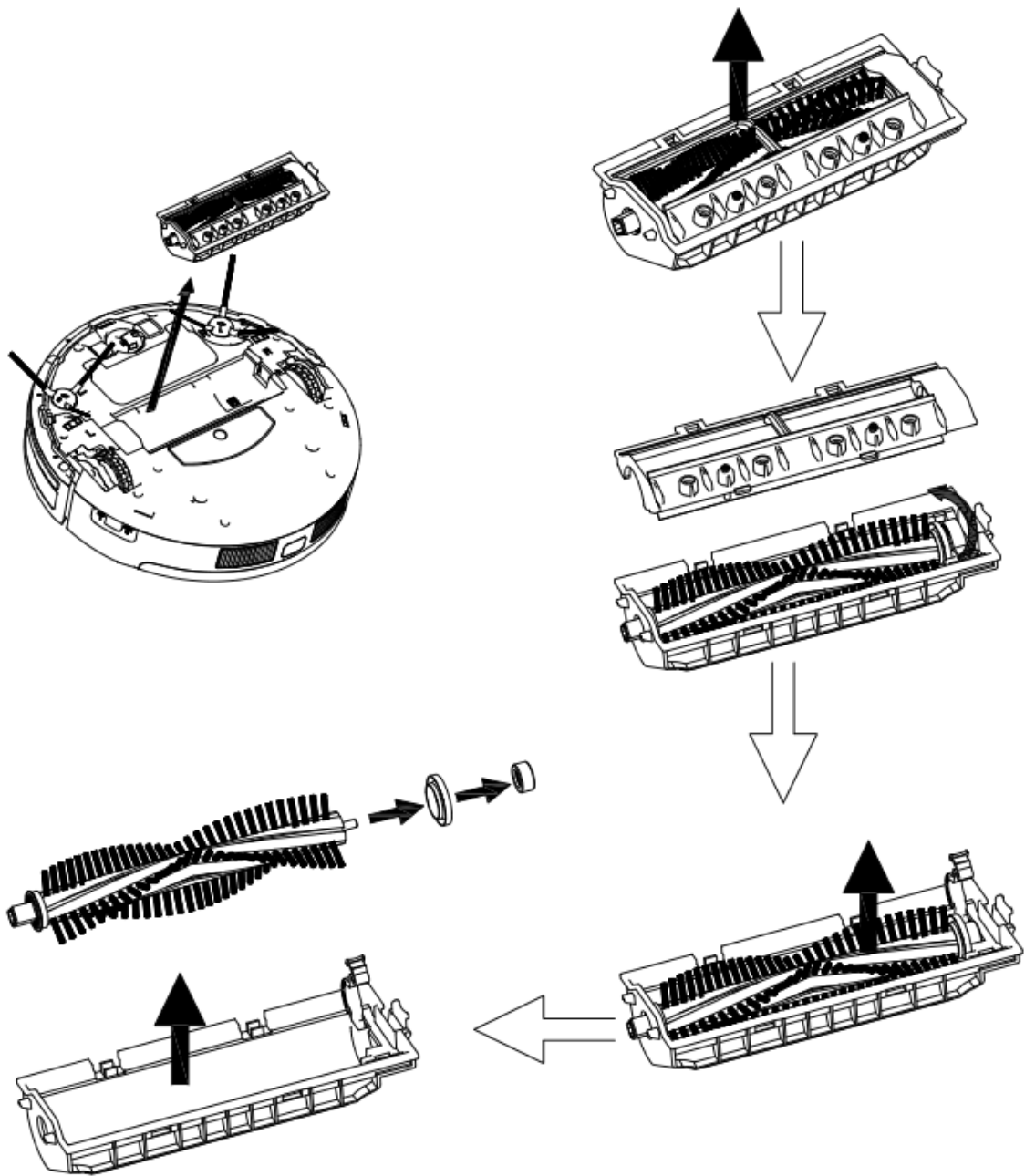



## TROUBLESHOOTING

Whenever a fault or error occurs, the LED Display will show a fault code. Refer to the following table for the probable cause and possible solution for each fault code.

Error Code	Cause	Solution
AUBF	Suction passage blocked	Clean the suction passage
AUBN	Dust bin missing or improperly installed	Ensure that the dust bin is properly installed
E1xx	Left collision switch fault	Check the sensitivity of the front bumper
E2xx	Right collision switch fault	
E3xx	Left and right collision switch fault	
E4xx	Left wheel off the ground	Put the vacuum on solid ground
E5xx	Left wheel off the ground, left collision switch fault	Put the vacuum on solid ground, check front bumper
E6xx	Left wheel off the ground, right collision switch fault	
E7xx	Left wheel off the ground, left and right collision switch fault	
E8xx	Right wheel off the ground	Put the vacuum on solid ground
E9xx	Right wheel off the ground, left collision switch fault	Put the vacuum on solid ground, check front bumper
Eaxx	Right wheel off the ground, right collision switch fault	
Ebxx	Right wheel off the ground, left and right collision switch fault	
Ecxx	Left and right wheels off the ground	Put the vacuum on solid ground

Edxx	Left and right wheels off the ground, left collision switch fault	Put the vacuum on solid ground, check front bumper
Eexx	Left and right wheels off the ground, right collision switch fault	
Efxx	Left and right wheels off the ground, left and right collision switch fault	
Exx1	Left anti-drop sensor detects a drop	Clean bottom anti-drop sensor
Exx2	Front anti-drop sensor detects a drop	
Exx3	Left and front anti-drop sensors detect a drop	Clean front sensor lens and bottom anti-drop sensor
Exx4	Right anti-drop sensor detects a drop	Clean bottom anti-drop sensor
Exx5	Left and right anti-drop sensors detect a drop	
Exx6	Front and right anti-drop sensors detect a drop	Clean front sensor lens and bottom anti-drop sensor
Exx7	Front, left, and right anti-drop sensors detect a drop	
Exx8	Front bumper right infrared sensor detects an obstacle	Clean front bumper sensor lens
Exx9	Left anti-drop sensor detects a drop, front bumper right infrared sensor detects an obstacle	Clean front sensor lens and bottom anti-drop sensor
ExxA	Front anti-drop sensor detects a drop, front bumper right infrared sensor detects an obstacle	
ExxB	Left and front anti-drop sensors detect a drop, front bumper right infrared sensor detects an obstacle	
ExxC	Right anti-drop sensor detects a drop, front bumper right infrared sensor detects an obstacle	

ExxD	Left and right anti-drop sensors detect a drop, front bumper right infrared sensor detects an obstacle	Clean front sensor lens and bottom anti-drop sensor
ExxE	Front and right anti-drop sensors detect a drop, front bumper right infrared sensor detects an obstacle	
ExxF	Front, left, and right anti-drop sensors detect a drop, front bumper right infrared sensor detects an obstacle	
Ex1x	Front bumper left infrared sensor detects an obstacle	Clean front bumper sensor lens
Ex2x	Front bumper middle infrared sensor detects an obstacle	
Ex3x	Front bumper left and middle infrared sensors detect an obstacle	
Ex4x	Front bumper right infrared sensor detects an obstacle	
Ex5x	Front bumper left and right infrared sensors detect an obstacle	
Ex6x	Front bumper middle and right infrared sensors detect an obstacle	
Ex7x	Front bumper left, middle, and right infrared sensors detect an obstacle	
Ex8x	Front bumper wall detection infrared sensor detects an obstacle	
Ex9x	Front bumper wall detection and left infrared sensors detect an obstacle	
ExAx	Front bumper wall detection and middle infrared sensors detect an obstacle	

ExBx	Front bumper wall detection sensor and left and middle infrared sensors detect an obstacle	Clean front bumper sensor lens
ExCx	Front bumper wall detection sensor and right infrared sensors detect an obstacle	
ExDx	Front bumper wall detection sensor and left and right infrared sensors detect an obstacle	
ExEx	Front bumper wall detection sensor and right and middle sensors detect an obstacle	
ExFx	Front bumper wall detection sensor and left, right, and middle infrared sensors detect an obstacle	
L01x	Fan overloaded	Check that the fan is not obstructed and clean dust bin
L02x	Roller brush overloaded	Check if it is stuck or obstructed by obstacles
L0x1	Left wheel overloaded	
L0x2	Right wheel overloaded	
L0x3	Left and right wheels overloaded	
L0x4	Left side brush overloaded	
L0x5	Left wheel and left side brush overloaded	
L0x6	Right wheel and left side brush overloaded	
L0x7	Left and right wheels and left side brush overloaded	
L0x8	Right side brush overloaded	
L0x9	Left wheel and right side brush overloaded	
L0xA	Right wheel and right side brush overloaded	

L0xB	Left and right wheels and right side brushes overloaded	Check if it is stuck or obstructed by obstacles
L0xC	Left and right side brushes overloaded	
L0xD	Left wheel and left and right side brushes overloaded	
L0xE	Right wheel and left and right side brushes overloaded	
L0xF	Left and right wheels and left and right side brushes overloaded	

Notes:

1. If the display shows **L000**, there is no problem. Reset the vacuum by turning in off then back on.
2. Replace the **x** in the above codes with whichever number is shown on the LED display.
3. If the display shows **E001** or **E004**, refer to both the **Exx1** and **Exx4** rows.
4. If the display shows **EC07**, refer to both the **ECxx** and **Exx7** rows.
5. If the display shows **EE91**, refer to both the **Exx1** and **Ex9x** rows.
6. If the suggested solution does not solve the problem, reset the vacuum by turning it off then back on.

## TECHNICAL SUPPORT

Monoprice is pleased to provide free, live, online technical support to assist you with any questions you may have about installation, setup, troubleshooting, or product recommendations. If you ever need assistance with your new product, please come online to talk to one of our friendly and knowledgeable Tech Support Associates. Technical support is available through the online chat button on our website [www.monoprice.com](http://www.monoprice.com) during regular business hours, 7 days a week. You can also get assistance through email by sending a message to [tech@monoprice.com](mailto:tech@monoprice.com)

## SPECIFICATIONS

Model	21714
Battery	2150mAh Lithium-ion
Input Power	24 VDC, 600mA
AC Adapter Input Power	100 ~ 240 VAC, 50/60 Hz, 0.5A
Dust Bin Capacity	0.5 liters
Cleaning modes	Auto, Spot, Edge, Zig-Zag, Schedule
Cleaning Time	90 ~ 100 minutes
Charging Time	240 ~ 300 minutes
Dimensions	13.4" x 3.5" (ø340 x 88 mm)
Weight	7.7 lbs (3.5 kg)

## REGULATORY COMPLIANCE

### Notice for FCC



This device complies with Part 15 of the FCC rules. Operation is subject to the following two conditions: (1) this device may not cause harmful interference, and (2) this device must accept any interference received, including interference that may cause undesired operation.

Modifying the equipment without Monoprice's authorization may result in the equipment no longer complying with FCC requirements for Class B digital devices. In that event, your right to use the equipment may be limited by FCC regulations, and you may be required to correct any interference to radio or television communications at your own expense.

This equipment has been tested and found to comply with the limits for a Class B digital device, pursuant to Part 15 of the FCC Rules. These limits are designed to provide reasonable protection against harmful interference in a residential installation. This

equipment generates, uses and can radiate radio frequency energy and, if not installed and used in accordance with the instructions, may cause harmful interference to radio communications. However, there is no guarantee that interference will not occur in a particular installation. If this equipment does cause harmful interference to radio or television reception, which can be determined by turning the equipment off and on, the user is encouraged to try to correct the interference by one or more of the following measures:

- Reorient or relocate the receiving antenna.
- Increase the separation between the equipment and receiver.
- Connect the equipment into an outlet on a circuit different from that to which the receiver is connected.
- Consult the dealer or an experienced radio/TV technician for help.