









Projector bracket parts

Parts	Picture	Standard package
1.Ceiling plate		1X
2.Projector plate		1X
3.Extension pipes		1X15CM
4.Extension pipes		1X8CM
5.Doble connector		-
6.Projector leg		3X
7.Hardware kit		1X
8.Rubber gasket		1X
9.Manual instructions		1X

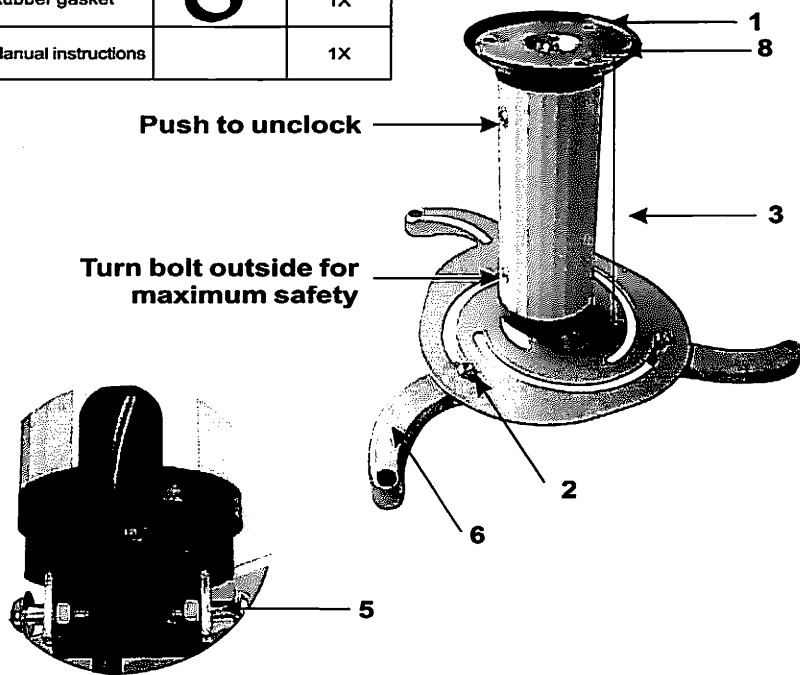

Manual Instructions

Universal Ceiling Projector Bracket

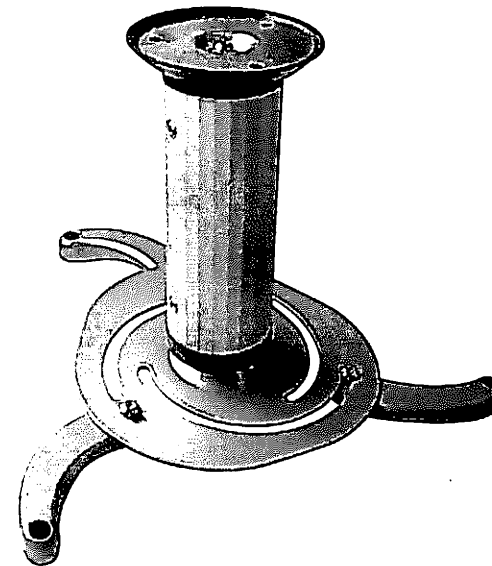
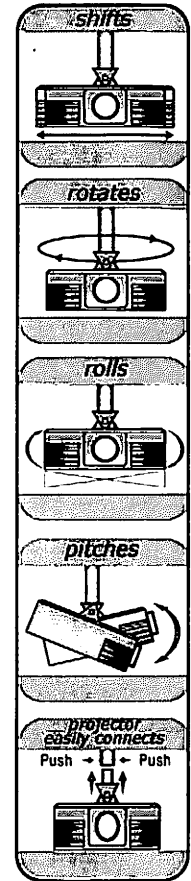
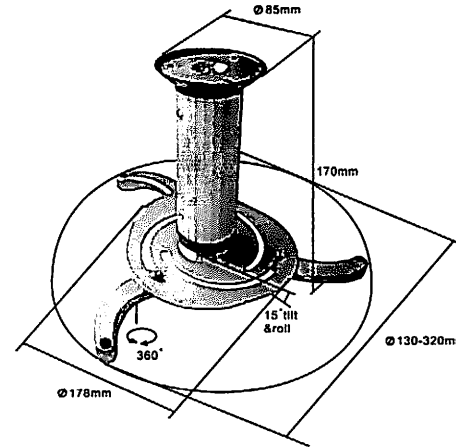

Assembly Instructions

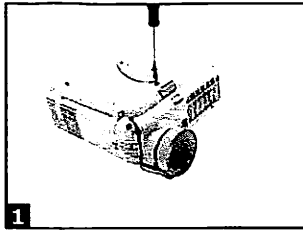

- Apply the video. Projector to the arms by using the screw M3 or M4 or M5 (do not fix, just apply)



- Work on the adjustable feet to have the arms at the same height

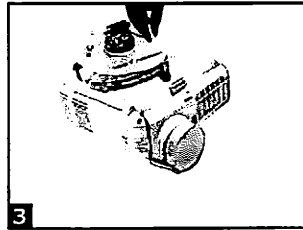

- Converge the arms to centre and fix the arms to bottom holes of the support by using the knobs

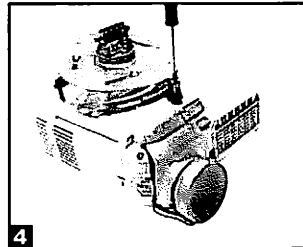

- Fix the screws

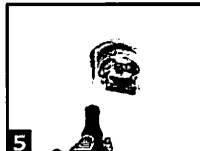

- Fix the support place to the ceiling, by using the three bottom moles

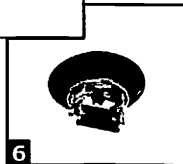

- Apply the cover ring to the ceiling supportplace

Assembly Instructions

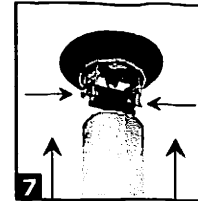

- Join the ceiling supportplate to the extension pipe pushing at the same time the two bolts

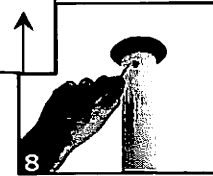

- Turn the bolts outside for the maximum safety

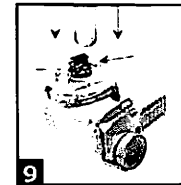

- Join the projector plate to the extension pipe pushing at the same time the two bolts



- Turn the bolts outside for the maximum safety

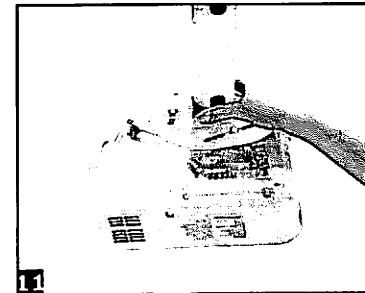

- Tilt the bracket as desired by working on the central part of the assembly swivel

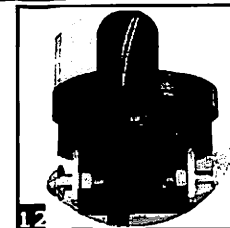

- Cables are hidden in the pipes