



**MP 35" Zero-G 100Hz Curved Monitor
with AMD FreeSync™ 2.0**



P/N 31005

User's Manual

SAFETY WARNINGS AND GUIDELINES

Please read this entire manual before using this device, paying extra attention to these safety warnings and guidelines. Please keep this manual in a safe place for future reference.

- This device is intended for indoor use only.
- Do not expose this device to water or moisture of any kind. Do not place drinks or other containers with moisture on or near the device. If moisture does get in or on the device, immediately unplug it from the power outlet and allow it to fully dry before reapplying power.
- Do not touch the device, the power cord, or any other connected cables with wet hands.
- Do not place the monitor on an unstable surface where it could fall and cause either personal injury or damage to the monitor and/or other equipment.
- Do not subject the product to extreme force, shock, or fluctuations in temperature or humidity.
- Do not expose this device to excessively high temperatures. Do not place it in, on, or near heat sources, such as a fireplace, stove, radiator, etc. Do not leave it in direct sunlight.
- This device ventilates excessive heat through the slots and openings in the case. Do not block or cover these openings. Ensure that the device is in an open area where it can get sufficient airflow to keep from overheating.
- Do not place or install this device in an area where it can be exposed to excessive amounts of dust, humidity, oil, smoke, or combustible vapors.
- Prior to operation, check the unit and power cord for physical damage. Do not use if physical damage has occurred.
- Before plugging the unit into a power outlet, ensure that the outlet provides the same type and level of power required by the device.
- Take care to prevent damage to the power cord. Do not allow it to become crimped, pinched, walked on, or become tangled with other cords. Ensure that the power cord does not present a tripping hazard.

- Never unplug the unit by pulling on the power cord. Always grasp the connector head or adapter body.
- Ensure that power is turned off and disconnected before making any electrical connections.
- Remove the batteries from the controller if it will go unused for a lengthy period of time.
- Clean using a soft, dry cloth only. Do not use chemical cleaners, solvents, or detergents. For stubborn deposits, moisten the cloth with warm water.
- This monitor has no user serviceable parts. Do not open the case or otherwise attempt to modify this monitor.
- Do not leave a single image on the display for a long period of time. Doing so could cause "burn-in" of the image. It is recommended to use a variable desktop background and to use a screen saver to prevent "burn-in". Alternatively, ensure that the monitor is powered off for at least 2 hours out of every 12.

FEATURES

- Three HDMI® and one DisplayPort inputs
- 3440 x 1440p @ 100Hz maximum video resolution
- Fully compliant with the HDMI 2.0 and DisplayPort 1.2 specifications
- 5ms GTG response time
- 178° vertical and horizontal viewing angles
- 500,000:1 dynamic contrast ratio
- 300 cd/m² brightness
- More than 16.7 million colors
- Includes IR remote control
- Supports AMD FreeSync™ 2.0

CUSTOMER SERVICE

The Monoprice Customer Service department is dedicated to ensuring that your ordering, purchasing, and delivery experience is second to none. If you have any problem with your order, please give us an opportunity to make it right. You can contact a Monoprice Customer Service representative through the Live Chat link on our website www.monoprice.com during normal business hours (Mon-Fri: 5am-7pm PT, Sat-Sun: 9am-6pm PT) or via email at support@monoprice.com

PACKAGE CONTENTS

Please take an inventory of the package contents to ensure you have all the items listed below. If anything is missing or damaged, please contact Monoprice Customer Service for a replacement.

1x 35" Curved Monitor	1x AC Power Adapter
1x Stand Base	1x AC Power Cord
2x Stand Legs	1x IR Remote Control
6x Stand Screws	2x AAA Batteries
1x High Speed HDMI® Cable	1x User's Manual

PRODUCT OVERVIEW

Input Panel

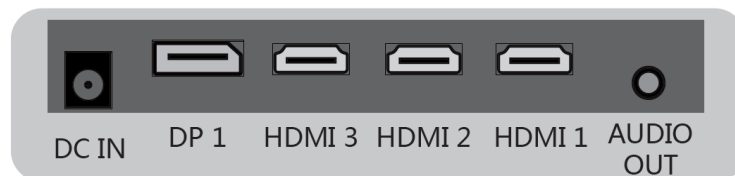

DC IN: DC barrel connector for connecting the included AC power adapter.

DP 1: DisplayPort video input supporting the DisplayPort 1.2 specification at resolutions up to 3440 x 1440p @ 100Hz.

HDMI 3: HDMI video input supporting the HDMI 2.0 specification at resolutions up to 3440 x 1440p @ 100Hz.

HDMI 2: HDMI® video input supporting the HDMI 1.4 specification at resolutions up to 3440 x 1440p @ 60Hz.

HDMI 1: HDMI® video input supporting the HDMI 1.4 specification at resolutions up to 3440 x 1440p @ 60Hz.

AUDIO OUT: 3.5mm stereo analog audio output.

Front

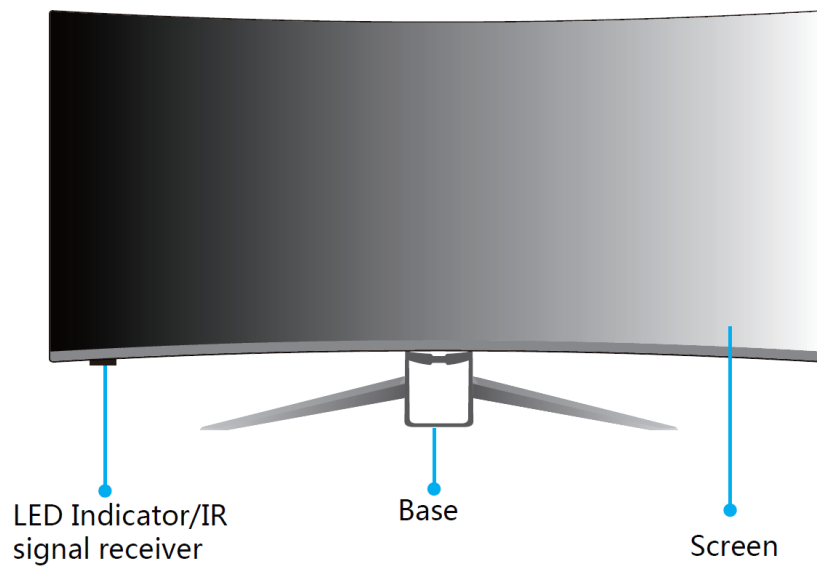

Rear

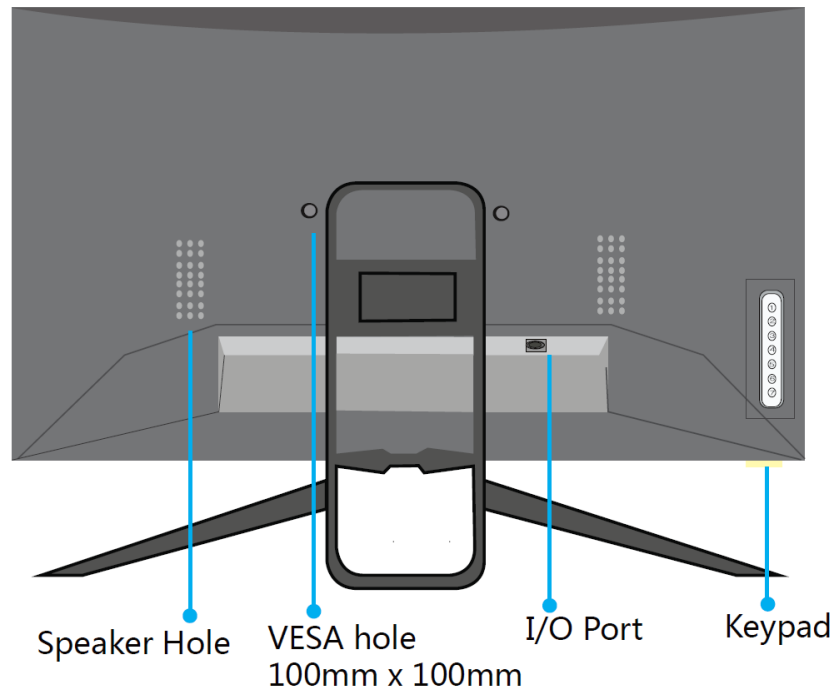

Keypad

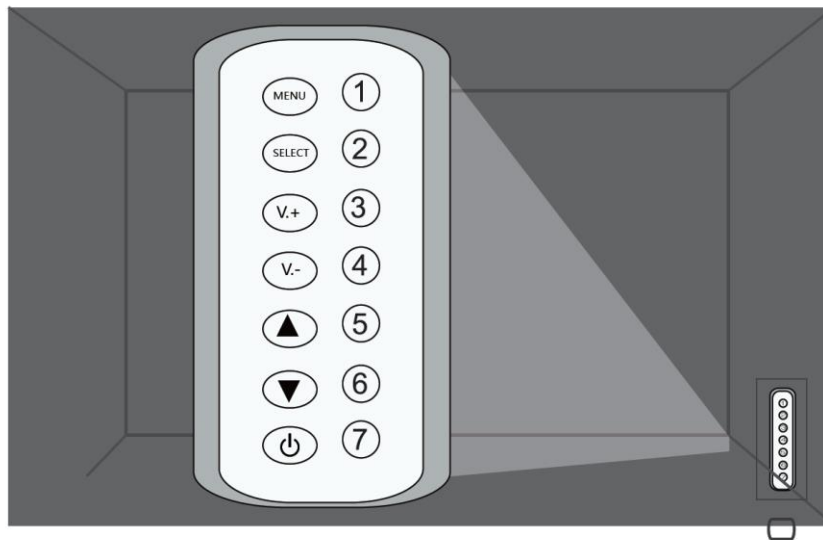

1. **MENU:** If the OSD menu is not displayed, press the **MENU** button to display the OSD menu. If the OSD menu is displayed, press the **MENU** button to select the highlighted function.

2. **SELECT:** Press the **SELECT** button to select the video input.
3. **V.+:** If the OSD menu is not displayed, press the **V.+** button to increase the volume level. If the OSD menu is being displayed, press the **V.+** button to move the highlight to the right.
4. **V.-:** If the OSD menu is not displayed, press the **V.-** button to decrease the volume level. If the OSD menu is being displayed, press the **V.-** button to move the highlight to the left.
5. **▲:** If the OSD menu is not displayed, press the **▲** button to adjust the aspect ratio. If the OSD menu is displayed, press the **▲** button to move the highlight up.
6. **▼:** If the OSD menu is not displayed, press the **▼** button to cycle through the crosshair modes. If the OSD menu is displayed, press the **▼** button to move the highlight down.
7. **⏻:** Press the **⏻** button to turn the monitor on or to put it in standby mode.

Remote Control



Turns the monitor on or puts it into standby mode.



Selects the video input.



Turns audio muting on or off.



Selects the image aspect ratio.



Up selects the channel.



Down selects the channel. Quick enter for target crosshairs.



Decreases the volume level.





Increases the volume level.



Displays the source.



Enters the OSD menu.



Exits the OSD menu.



Quick enter for low blue mode.



Quick enter for ECO mode.



Quick enter for sleep mode.

INPUT SOURCE MENU

- Press the **SELECT** button on the Keypad to display the Input Source Menu.
- Use the ▲ and ▼ buttons to move the highlight to the desired input.
- Press the V.- button or wait 3 seconds to select the highlighted input.
- Select the **AUTO** option allow the monitor to automatically switch to the active input.

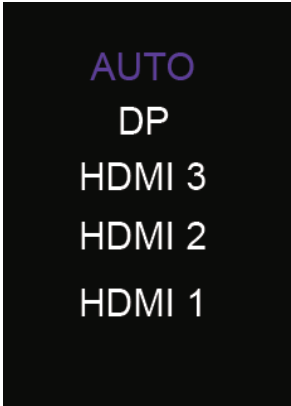

AUTO
DP
HDMI 3
HDMI 2
HDMI 1

INSTALLING THE STAND

Unless you will be using a wall or desk mount, you will need to install the stand before you can use the monitor. Perform the following steps to install the stand.

1. Remove the monitor from the box, but leave the foam packing on it.
2. Using two of the included Stand Screws, attach the two Stand Legs to the Stand Base, as shown in the images below.

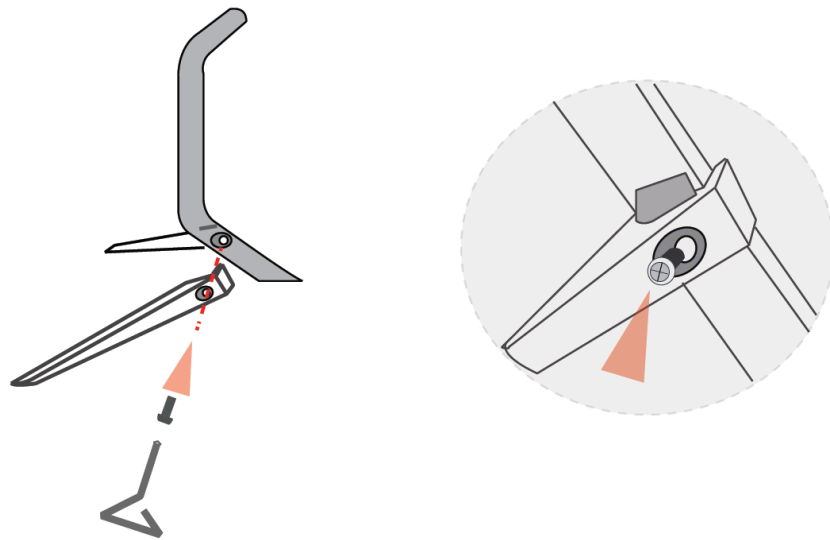

3. Place a towel or blanket on a flat work surface to protect the monitor while installing the stand.
4. Place the monitor with the foam packing face down on work area, then attach the Stand Base to the back of the monitor using the four remaining Stand Screws, as shown in the images below.

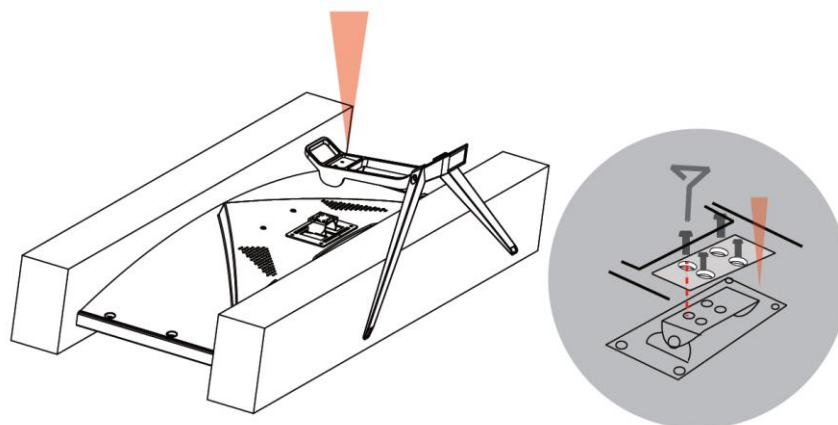

INSTALLATION

1. Ensure that all equipment to be connected is powered off and unplugged from their power sources.
2. Place the monitor at its intended location.
3. Using the included High Speed HDMI® Cable, plug one end into one of the HDMI inputs on the monitor, then plug the other end into the HDMI output on your PC. Note that **HDMI 3** supports the HDMI 2.0 specification at up to 100Hz refresh rate, while **HDMI 1** and **HDMI 2** support the HDMI 1.4 specification at up to 60Hz refresh rate.
4. Plug the DC barrel connector on the included AC Power Adapter into the **DC IN** jack on the Input Panel.
5. Plug the included AC Power Cord into the C14 connector on the AC Power Adapter, then plug the other end into a nearby AC power outlet.

OSD MENU MAP

Main Menu Item	Sub Menu Item	Option	Function	
BRIGHTNESS	BRIGHTNESS	0~100	Level can be adjusted from 0 to 100	
	CONTRAST	0~100	Level can be adjusted from 0 to 100	
	BLACK LEVEL	0~100	Level can be adjusted from 0 to 100	
	ECO	STANDARD		Choose the picture mode.
		TEXT		
		GAME		
		MOVIE		
	ECO			
	FPS1			

Main Menu Item	Sub Menu Item	Option	Function
BRIGHTNESS	ECO	FPS2	Choose the picture mode
		RTS	
		HDR	
		TV MODE	
	DCR	OFF	Dynamic contrast ratio on or off.
		ON	
	CROSSHAIR TARGET	TARGET 1	Select crosshair style 1
		TARGET 2	Select crosshair style 2
		TARGET 3	Select crosshair style 3
	LOW BLUT	OFF	Removes the blue color of the image to protect your eyes
		ON	
	UP SCALING	OFF	Disables up scaling
ON		Enables up scaling	
POSITION	ASPECT	WIDE	Choose the aspect ratio
		4:3	
		5:4	
		16:9	
		1:1	
		AUTO	
	DP VERSION	DP 1.2	Displays the DisplayPort version
COLOR	COLOR TEMP.	WARM	Selects the basic color temperature
		USER1	
		USER2	

Main Menu Item	Sub Menu Item	Option	Function
COLOR	COLOR TEMP	USER3	Selects the basic color temperature
		COOL	
		SRGB	Selects the basic color temperature
	RED	0~100	Adjusts the amount of red color in the image
	GREEN	0~100	Adjusts the amount of green color in the image
	BLUE	0~100	Adjusts the amount of blue color in the image
OSD SET	LANGUAGE	English, etc.	Choose the OSD menu language
	OSD H.POS	0~100	Adjusts the horizontal position
	OSD V.POS	0~100	Adjusts the vertical position
	OSD TIME	0~60	Adjusts the amount of time the OSD menu stays on screen without any input
	TRANSPARENCY	0~100	Adjusts the transparency/opacity of the OSD menu.
	OSD SIZE	NORMAL	Adjusts the size of the OSD menu
		LARGE	
	OSD ROTATION	OFF	Sets the amount of rotation of the OSD menu
90			
180			
270			
RESET	RESET		Resets all settings to the factory default values

Main Menu Item	Sub Menu Item	Option	Function
MULTIWIN	MULTI-WINDOW MODE	OFF	Single picture mode
		PIP MODE	Picture-in-picture mode
		PBP 2WIN	Split screen modes
		PBP 3WIN	Split screen modes
		PBP 4WIN	
	WINDOW 2 INPUT	HDMI 1	Selects the input source for window 2
		HDMI 2	
		HDMI 3	
		DP 1	
	WINDOW 3 INPUT	HDMI 1	Selects the input source for window 3
		HDMI 2	
		HDMI 3	
		DP 1	
	WINDOW 4 INPUT	HDMI 1	Selects the input source for window 4
		HDMI 2	
		HDMI 3	
		DP 1	
	PIP SIZE	MEDIUM	Adjusts the size of the PIP window
		LARGE	
		HUGE	
SMALL			
PIP POSITION	TOP LEFT	Adjusts the position of the PIP window	
	TOP RIGHT		

Main Menu Item	Sub Menu Item	Option	Function
MULTIWIN	PIP POSITION	BOTTOM LEFT	Adjusts the position of the PIP window
		BOTTOM RIGHT	
	SWAP		Swaps the main and PIP inputs
SET 2	SIGNAL SOURCE	AUTO	Selects the desired input source
		DP 1	
		HDMI 3	
		HDMI 2	
		HDMI 1	
	MUTE	OFF	Switches audio muting on or off
		ON	
	AUDIO IN	AUTO	Selects the audio source
		DP 1	
		HDMI 1	
		HDMI 2	
		HDMI 3	
	VOLUME	0~100	Adjusts the volume level
	FREE SYNC	OFF	Turns AMD FreeSync™ on or off for use with AMD video cards and the DP input
		ON	
HDR	AUTO	Sets the HDR function	
	SMPTE 2084		
	OFF		

Main Menu Item	Sub Menu Item	Option	Function
SET 2	OVER DRIVER	OFF	Sets the level of overdrive
		WEAK	
		MEDIUM	Sets the level of overdrive
		STRONG	
	SLEEP MODE	OFF	Sets the amount of time before the monitor will automatically go into standby mode
		10 MIN	
		20 MIN	
		30 MIN	
		40 MIN	
		50 MIN	
		60 MIN	
120 MIN			
240 MIN			

TECHNICAL SUPPORT

Monoprice is pleased to provide free, live, online technical support to assist you with any questions you may have about installation, setup, troubleshooting, or product recommendations. If you ever need assistance with your new product, please come online to talk to one of our friendly and knowledgeable Tech Support Associates. Technical support is available through the online chat button on our website www.monoprice.com during regular business hours, 7 days a week. You can also get assistance through email by sending a message to tech@monoprice.com

SPECIFICATIONS

Model	31005
Screen Size	35" (889.8 mm)
Active Area	32.3" x 13.6" (819.4 x 345.9 mm)
Maximum Resolution	3440 x 1440p @ 100Hz
Viewing Angles (H/V)	178° / 178°
Response Time (GTG)	5ms
Brightness	300 cd/m ²
Contrast Ratio	2500:1
Dynamic Contrast Ratio	500000:1
Number of Colors	> 16.7 million
Speakers	2x 5 watts
Stand Tilt Range	+13° / -3°
Input Power	24 VDC, 3A
AC Adapter Input Power	100 ~ 240 VAC, 50/60 Hz
Maximum Power Consumption	72 watts
Standby Power Consumption	≤ 0.5 watts
Dimensions (without stand)	32.8" x 14.9" x 2.8" (834 x 377 x 72 mm)
Weight (without stand)	18.6 lbs. (8.45 kg)

AMD® and FreeSync™ are trademarks of Advanced Micro Devices, Inc. in the United States and/or other jurisdictions.

HDMI®, the HDMI Logo, and High-Definition Multimedia Interface are trademarks or registered trademarks of HDMI Licensing LLC in the United States and other countries.