



INSTALLATION GUIDE

Super Thin TV Wall Mount

MDSF63

Support 37" to 63" Screens

Max Load Capacity: 200 lbs (68 kg)

VESA 500x800 compatible



Installation Instructions

Model Name:MDSF-63

37"-63" SUPER SLIM LCD TV WALL MOUNT

Important Notes

- Your screen will be only 0.59" from the wall.
- Unique horizontal level marker for easy installation.
- The 37"-63" universal fixed wall mount supports a maximum load of 68 kg(150lbs).
- The manufacturer does not accept responsibility for incorrect installation.

Component Checklist

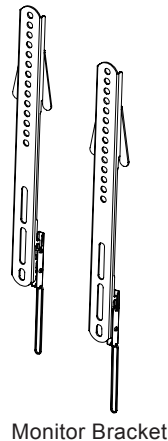
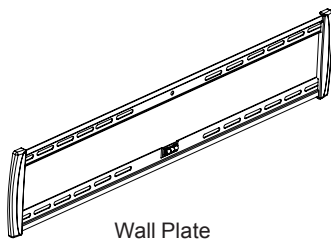

PARTS LIST

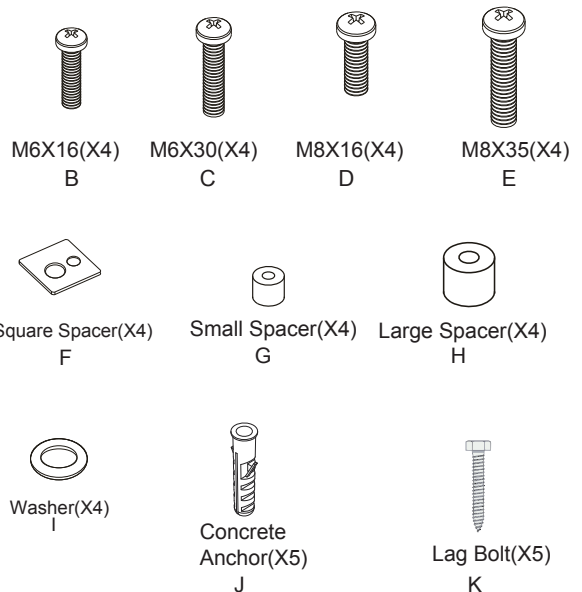

TOOLS REQUIRED:

- Power Drill
- 10mm or 6mm Drill Bit
- Phillips Head Screw Driver
- Level
- 13mm (1/2") Socket Wrench

1 Mounting Wall Plate

Masonry Wall

Note: Ensure the wall plate is mounted with the folded tabs pointing upwards.

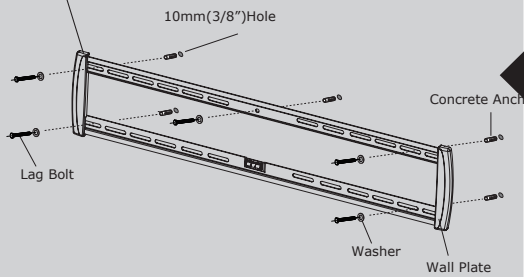

TIP: Use a level to ensure the wall plate is leveled



Timber Stud Wall

Note: Ensure the wall plate is mounted with the folded tabs pointing upwards.

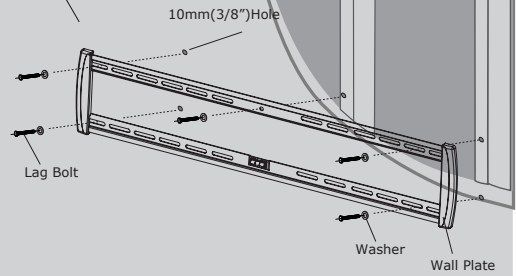

2 Mounting Display Brackets

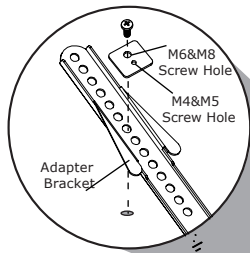

* NOTE:
When attaching the mounting screws to the display, make sure the direction of Brackets is correct and ensure that both brackets are vertically aligned.

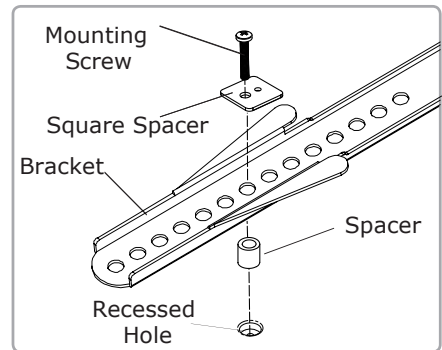
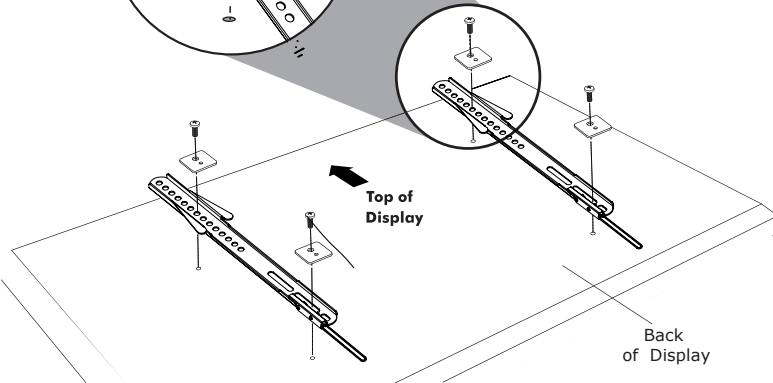

3 Attaching Display to Wall Plate

Note: This procedure requires two people

